

RADIO'S GREATEST MAGAZINE

K

RADIO-CRAFT

Incorporating

**RADIO &
TELEVISION**

HUGO GERNSBACH, Editor



OCTOBER

25¢

CANADA 30¢

1942

See Page 26

OVER 100 ILLUSTRATIONS

TRIPLETT

Thin-Line INSTRUMENTS

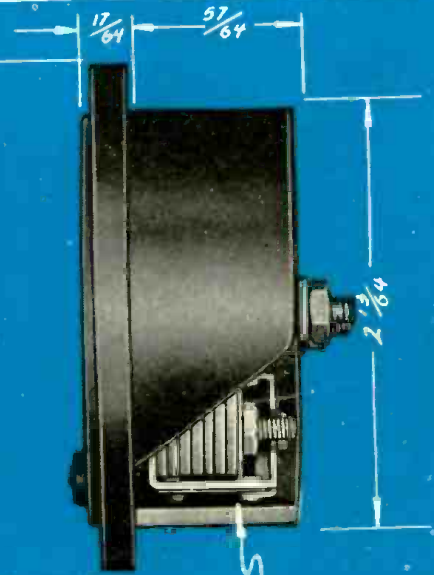

NOTE - THIN MOLDED CASE WITH FULL SIZE TRIPLETT MECHANISM.

FULL SIZE TRIPLETT MECHANISM.



INSTRUMENT "SPECS"

- Minimum case depth.
- Full standard size rigid mechanism . . . no projecting base.
- Wider shroud strengthens face: focuses attention on scale.
- Simplified zero adjustment.
- Sapphire or equivalent jewels. All component parts finely made and of superior quality.
- Balanced Bridge Support.
- Metal Bridges at both ends.
- Separate Scale Mounting.
- Doubly Supported Core.

Also available in metal case

NOTE: When space is at a premium and for all installations where space is efficiently used, Triplet Thin-Line Instruments set a new standard of precision performance in "condensed" space. For full details write for Triplet Thin-Line Bulletin to The Triplet Electrical Instrument Co., Bluffton, Ohio.



DIMENSIONS OVERALL WITH STUDS & NUTS. ORDER K. S. 8789

0221-T

THE TRIPLETT ELECTRICAL INSTRUMENT CO.
BLUFFTON, OHIO, U. S. A.

DRAWN * H. A. 4-29-42
CHECKED W. F. 5-16-42
APPROVED F. B. 5/16/42

5417X

**Men NOW in Radio
who Don't Think
they know it All
Read This**

If you're a Serviceman, you don't want to see younger men with modern training getting the cream of the Radio repair business, now booming because of the shortage of new sets. If you're an Operator, you don't want to be baffled by new Radio circuits and equipment. Extra knowledge wins you extra money, promotions. Read my message, below.

**J. E. SMITH, President
NATIONAL RADIO INSTITUTE
Established 27 years**

He has directed the training of more men for Radio than anyone else. He has helped men already in Radio to get ahead, and men not in Radio to get into Radio and win success.



**If You're NOT
Working in Radio Now
Read This**

You can begin cashing in on your interest in Radio QUICK—IF YOU ACT NOW! The Radio repair business, booming because of the shortage of new home and auto Radios, offers more opportunities than ever to make \$30, \$40, \$50 a week in full-time jobs, or \$5, \$10 extra a week if you hold your present job and fix Radio sets in spare time. Practically all branches of Radio need Technicians, Operators. Radio training can win extra rank, pay in Army, Navy. Find out how I train you at home in spare time for Radio's opportunities. MAIL THE COUPON BELOW—NOW!

Make Me Prove I Can Train You at Home to Be a RADIO TECHNICIAN or OPERATOR

Clip the coupon and mail it. I'm certain I can train you at home in your spare time to be a Radio Technician. I want to send you a sample lesson free; to examine, read. See how clear my Course is to understand. See how my Course is planned to help you get a good job in Radio, a young growing field with a future. You don't have to give up your present job, or spend a lot of money to become a Radio Technician. I train you at home nights in your spare time.

Charles F. Helmuth, 16 Hobart Ave., Absecon, N. J., writes, "I started Radio in the Marines. Later I took the N. R. I. Course. Now I am my own boss and get jobs over others who thought they had them. I owe plenty to N. R. I. Training." James E. Ryan, 119 Pebble Ct., Fall River, Mass., writes, "I was working in a garage when I enrolled with N. R. I. I am now Radio Service Manager for the M— Furniture Co. for their four stores."

**Why Many Radio Technicians I Trained
at Home Make \$30, \$40, \$50 a Week**

The up-to-the-minute Radio Technician or Operator must have BOTH a thorough knowledge of Radio, and experience working with Radio parts and equipment such as my training gives you. That is why men I trained are taking advantage of the booming Radio repair business to get better jobs, to make more money in spare time, or to open their own Radio repair businesses. Others fill good-pay jobs in many of the country's 882 Broadcasting Stations, and in Aviation, Police, Commercial, Marine and Government Radio. Loud-Speaker Systems give good

jobs to many. Others, in the Army or Navy, are winning promotion, extra pay, because of their Radio training. Government orders for Radio Equipment have opened new jobs for many in Radio Factories, while many have good Civilian Government Jobs as Radio Technicians, Operators.

My Course Is Thorough and Practical

I give you a thorough basic training in Radio Theory and Practice which enables you to understand the operation of practically every type of Radio Equipment. I send you 6 Big Kits of Radio Parts with which you build Radio circuits and testing equipment, conduct tests and experiments which give you practical experience. That's why many men I train begin to make more money quickly and get and hold good jobs.

**Beginners Quickly Learn to Earn \$5 to \$10
a Week Extra in Spare Time**

Nearly every neighborhood offers opportunities for a good part-time Radio Technician to make extra money fixing Radio sets. I give you special training to show you how to start cashing in on these opportunities early. You get Radio parts and instructions for building test equipment, for conducting experiments that give you valuable practical experience. My 50-50 method of training—half with Radio parts I send you, half studying my Lessons—makes learning Radio at home interesting, fascinating, practical.



**EXTRA PAY IN ARMY,
NAVY TOO**



Men likely to go into military service, soldiers, sailors, marines, should mail the Coupon Now! Learning Radio helps men get extra rank, extra prestige, more interesting duties, much higher pay. Also prepares for good Radio jobs after service ends. IT'S SMART TO TRAIN FOR RADIO NOW!

MAIL THE COUPON—get my FREE Lesson and 64-page book, "Rich Rewards in Radio," at once. See what Radio offers you as a skilled Radio Technician. Learn how practical my Course really is. Real letters from more than 160 men I have trained so you can see what they are doing and earning. Mail the Coupon NOW—in an envelope or paste it on a penny postal.

J. E. SMITH, President, Dept. 2KX
National Radio Institute
Washington, O. C.

TRAINING MEN FOR VITAL RADIO JOBS

**GOOD FOR BOTH 64 PAGE BOOK FREE
SAMPLE LESSON FREE**

J. E. SMITH, President, Dept. 2KX
National Radio Institute, Washington, D. C.

Dear Mr. Smith: Mail me FREE, without obligation, your Sample Lesson and 64-page book, "Rich Rewards in Radio," which tells about Radio's spare-time and full-time opportunities and explains your 50-50 method of training men at home to be Radio Technicians. (No salesman will call. Write plainly.) (Please check.)

() I AM doing Radio work, () I am NOT doing Radio work.

Name Age

Address

City State 2FR



SAMPLE LESSON FREE

Get my Sample Lesson "How Radio Programs are Sent from the Studio to Your Home." It traces a Radio program from the studio microphone to your loudspeaker. 32 diagrams, pictures and photographs explain every step clearly. You learn the appearance and use of Radio parts, learn to read simple diagrams, become acquainted with coils, condensers, resistors, power supplies, sound, modulation, R. F. and A. F. circuits. See for yourself how complete, how practical my Lesson—NOW.
MAIL THE COUPON—NOW.

RADIO-CRAFT

Incorporating

RADIO & TELEVISION

HUGO GERNSBACK
Editor-in-Chief

HARRY CONVISER
Managing Editor

G. ALIQUO
Circulation Manager

IN THE NEXT ISSUE
The November issue will contain a diversified list of selected articles for the

● **RADIO BEGINNER**, in addition to the usual features.

Contents OCTOBER, 1942 Issue

VOLUME XIV -- NUMBER 1

Mailbag	4
Editorial: Deadly Radio Transmission	7
The Radio Month in Review	8

SERVICING

Practical Transformer Design	10
Analysis & Alteration of an Analyzer	12
Tracking Down Grid Emission	14
Testing Small Power Transformers	15
RADIO SERVICE DATA SHEET:	
No. 326 Emerson Model 436 High-Fidelity A.C. Superheterodyne	16
Low-Capacitance A-C Power Supplies	18
by Garrard Mountjoy and Charles W. Finnigan	
Receiving Tube Charts	20
Making A Voltmeter Read Watts	22
by W. G. Lofstrom	
B- and C- Battery Eliminator for Service Test Bench	23
by Russell E. Powers	
Transformerless Power Supplies—Part I	24

RADIO INSTRUCTION

Flight Radio School Trains Enlisted Men	26
Signal Corps Training Begun at Illinois Tech	27

SOUND

Factors Contributing to Good Recording	28
by R. A. Lynn	
Sound as an Aid to Navigation	30
by Willard Moody	
Devices for Air Raid Warnings	30
Wide-Range Film Recording Developed for Home Use	32
by H. W. Knettelt	

ENGINEERING

Radio Direction Finders	34
by Willard Moody	
In-Phase Amplifier; Designing a Non-Phase-Reversing Stage	36
by R. C. Whitehead	

DEPARTMENTS, ETC.

Mailbag	4
The Radio Month in Review	8
RADIO SERVICE DATA SHEET (See Servicing)	16
Operating Notes	19
Latest Radio Apparatus	37
Book Reviews	63

RADIO & TELEVISION

How to Make a 2 $\frac{3}{4}$ " x 4" Receiver	39
by Irving Minton	
Egg-Fertility Radio Tester	40
11-Tube Frequency Modulation Receiver	42
by George Francis Baptiste	
Getting Started in Radio	46
by C. W. Palmer	
Which Regeneration Scheme?	48
by M. Harvey Gernsback	
Radio Kinks	50
Radio Patents Digest	60



Published by Radcraft Publications, Inc. Publication office: 29 Worthington Street, Springfield, Mass. Editorial and Advertising Offices: 25 West Broadway, New York City. Chicago Advertising Office: RADIO-CRAFT, 520 North Michigan Avenue, Chicago, Ill.

RADIO-CRAFT is published monthly, on the first of the month preceding that of date; subscription price is \$2.50 per year in U. S. (In foreign countries, 75c additional per year to cover postage; Canada, 50c additional.) Entered at the post office at Springfield as second-class matter under the act of March 3, 1879. All communications about subscriptions should be addressed to: 29 Worthington Street, Springfield, Mass., or Director of Circulation, 25 West Broadway, New York, N. Y.



Foreign Agents:

London—Gorrings's American News Agency, 9A Green St., Leicester Square, W. C. 2, England.

Paris—Messageries Dawson, 4 Rue Faubourg, Poissonniere, France.

Melbourne—McGill's Agency, 179 Elizabeth St., Australia.

Dunedin—James Johnston, Ltd., New Zealand.



Text and illustrations of this magazine are copyright and must not be reproduced without permission of the copyright owners.



Copyright 1942 Radcraft Publications, Inc.



**Selected
for Dependability**



Murdock
**RADIO
PHONES**

The lives of America's fighting men—the winning of America's battles depend on swift, **sure** radio communications.

Army radio equipment **must** be completely dependable. Exacting Army specifications make sure it **will** be.

The Air Corps and Signal Corps test, approve, and **use** Murdock Radio Phones.

MURDOCK MANUFACTURING COMPANY—Chelsea, Mass.

The name is new
... the Purpose
is not Changed

On July 30, 1942,
the stockholders of
**HYGRADE SYLVANIA
CORPORATION**
voted to change
the company name
to
SYLVANIA
ELECTRIC
PRODUCTS INC.

AS of July 30, 1942, the Hygrade Sylvania Corporation became Sylvania Electric Products Inc.

Needless to say, the change is one in name only.

There is no change in the high quality of our products, no turning from our purpose to bring forth the finest lighting and radio equipment our skill and experience can create.

And that means we will continue to provide you with an incomparable line of radio tubes, backed by all the technical assistance and promotional help you need to do a first-rate selling job.



SYLVANIA

ELECTRIC PRODUCTS INC.

formerly

HYGRADE SYLVANIA CORPORATION

Emporium, Pa.

Also makers of Incandescent Lamps,
Fluorescent Lamps and Fixtures

2.5-VOLT TUBES

Dear Editor:

I am but a beginner in radio although very much interested in it. I find the cost of parts very high, and so I salvage most of mine from old sets. The tubes of most of these sets use two and a half volts in the heaters and the power transformer produces this. To build many sets illustrated in your magazine six-volt tubes and transformers with six-volt filament windings must be used.

Could you not publish suitable circuit diagrams using these parts? I believe there are others who would appreciate such circuits.

DONALD MILLER,
Parry Sound, Ontario, Canada

(Most of the general-purpose tubes are available in 2.5-volt filaments as well as 6.3-volt filaments. These include triodes, pentodes and output tubes whose characteristics are either similar or very nearly similar in both types of filaments. Substitutions of 2.5-volt tubes can be selected from any manufacturer's tube manual by comparing the characteristics data. Of course, metal tubes and some of the more recent special-purpose tubes can be obtained only for 6.3 volts. Where simple revisions for 2.5-volt tubes can not be made, a separate 6.3-volt transformer can be wound for the core of an old audio transformer by following the practical design data given by Mr. Shunaman in this issue.—Editor)

POCKET-SIZE RADIO

Dear Editor:

I had noticed in a recent issue of your magazine your asking the readers to state the kind of articles they desire.

I look on this as a grand opportunity, being somewhat a novice on set building. I do have in my mind what I would like and hope to see it in your magazine in some future issue.

I would truly appreciate your publishing my desires in the Mailbag! Hoping there are beginners, in uniform or otherwise, who will find the article I want to be what they want, too!

I would like to see an article on a truly pocket-size radio, a set that could be truly a "vest-pocket companion" for the soldier on the march, etc.

For the sake of keeping the set small as possible, why not use Irl Gordon's suggestion in your June issue and use the popular midget "hearing aid" type of tube. I would like the set to be a "one-tuber"! And using the crystal detector as well would be dandy.

The type of set in question would prove a real traveling companion.

PVT. CYRIL COWPER,
Toronto, Canada

OSCILLATOR-COIL DATA

Dear Editor:

In reference to Mr. William F. Santelmann's letter in the July issue of *Radio-Craft* regarding the design of superheterodyne oscillator coils, the desired information can be found in Terman's "Radio Engineering," in the "Radiotron Designers Handbook," and undoubtedly in many other similar texts. While the derivation of these equations is beyond the scope of the average experimenter, it requires no great knowledge of mathematics to be able to substitute into these formulas for the value of the unknown component.

JOHN L. BELFI,
New York, N. Y.

SERVICING DOPE

Dear Editor:

I like R-C. I've read it since Hector was a pup. Even before Buck and Moody started grabbing more free space than Victor Mature.

I have my own shop, located here 4 years, and I am doing very nicely. I have plenty of good equipment, try to do a good, honest job and treat people squarely. I am proud of the fact that most of my first customers are still my customers and friends. This is a small town, 1,600 inhabitants, with closely populated surrounding country, and news, good or bad, travels fast. In addition to my own business, I do work for six garages and two electric stores on a wholesale basis. Of course, all work is done in my own shop. I find this wholesale business a steady and substantial portion of my gross business. I also take care of two locally owned P.A. outfits.

I like articles concerning unusual servicing problems, equipment and P.A.; real, meaty dope that helps pay the rent and keeps customers satisfied. How about some additional articles on aircraft detectors and related subjects. I've gotten plenty of good dope, advice and ideas from R-C in the past, and I look for plenty more in the future.

BURNIE ADAMS,
Fortuna, Calif.

(Most of our service articles are written by men like yourself—servicemen. We are eager to publish the "meaty dope" but we are almost wholly dependent on readers for this material, since most of our former "specialists" are busy aiding in the war effort. You might try to relate some of your own service-problem solutions, or describe any unusual equipment you may have.—Editor)

COOKE'S SLIDE RULE

Dear Editor:

For three years now I have been reading your magazine and have found it not only interesting but also very educational.

Now that I wish to write in for information I can find no instructions as to who or where to write.

I have the Cooke's mathematical book for radio repairmen and electricians and I wish to know where I can buy a Cooke's slide rule.

C. MC HENRY,
Canon City, Colo.

(We know of this slide rule only from the book recently published. We tried to buy one at several stores but were unable to find one. Perhaps some of our readers can furnish the information.—Editor)

RADIO IN THE ARMY

Dear Editor:

I am a subscriber of *Radio-Craft* magazine and like it very much. I am taking a correspondence course in Radio Electronics from the National School of Electronics of Minneapolis, and I am very much interested in radio. I am thinking about joining the Army Signal Corps sometime before I am drafted into the Army. Why don't you have articles in your magazine about radio in the Army and give us a writeup about the Signal Corps?

RAY JEAN BATTS,
Thorntown, Ind.

(We can not publish information that might be useful to the enemy.—Editor)

THE AMATEUR AND THE WAR

Dear Editor:

I feel that I have been cheated by the Japanese, or Germans, or the F.C.C. or someone. To explain this I will have to give you some of my past history.

I became interested in radio in the winter of 1939. I listened to amateurs on the short-wave end of my broadcast receiver. I also read radio books here and there for about a year. I got a telegraph set and learned to send up to about 12 w.p.m. on it. Then I got a key and buzzer. In May of 1941 I built a two-tube battery radio and had much trouble with it. I did not get it to operate until July, 1941. Also in May I bought a license manual and radio amateur's handbook, and rented a Teleplex instrument. It was two months before the Teleplex came, because of war needs. I studied in all of my spare time until September 22, 1941. That day I went 165 miles to Dallas and took my examination. I passed the code exam swell and I figure that I made about 85 on the questions.

From then until December 6, 1941, the day when my licenses came through the mail, I built my station. I bought a Sky Buddy receiver and built a 25-watt transmitter and a lot of other equipment. The only thing was that my antenna was broken by a high wind and replacement had to wait several days before I could get some more of the right kind of wire. On December 8, I finished it and was ready to go on the air for the first time in my life. I was excited all over. I had been waiting for this hour for two years. Then I heard over the broadcast receiver about the F.C.C. closing all amateur stations. You can imagine how I felt.

Between December and February, 1942, I did not see a R & T magazine. Without it, I could not read about what was happening in the radio field. Now I have forgotten nearly all I knew; I can't send or receive over about 10 w.p.m.; I have forgotten most of the ham slang and every-

WANTS SIMPLE SUPERHET

Dear Editor:

Your magazine is unbeatable in its field. I would like to see some circuits, using metal tubes, for a simple two or three-tube superhet with regeneration. After a pleasant while of building the one- and two-tube regenerative sets, a lot of fellows would like to build a simple "super."

More power to your good magazine!
 GEORGE P. BLACKBURN,
 Tyler, Tex.

WON'T STAY IN THE GROOVE

Dear Editor:

I have a portable phonograph which has been giving me a great deal of trouble, and for that reason am writing you for some information.

It has the old type of sound-box, that is, with the diaphragm type pickup, which as you know is quite heavy. It has cost me a lot of money as I have had quite a few records of value ruined.

This is what happens: When the record is put on the turn-table and the arm put on the record, it jumps grooves in the record whenever the arm strikes a heavily recorded portion of the record, and as you know, the recordings today are being made with extremely high volume so as to counteract surface noise. Because of this, it has been necessary for me to put a great deal of money into needles and replacement of records which I have had ruined. During the winter months I did not mind it because I do not use it quite as much but

thing. I am very unhappy. I suppose a lot of other amateurs are, too.

The government claims it uses the amateur bands for aviation and army use. I have a good communication receiver and I search all over the amateur bands and I can't hear anything. Not even a telegraph signal. Why can't the F.C.C. give us amateurs just a little space to operate. For instance, they could give us back the 160-meter band and not let us use over 40 watts input and operate only during a certain period of the day.

There are a lot of amateurs in the army and on defense jobs, but there are still some left, like the ones under 17 and over 64, or the blind, deaf, or disabled, who love amateur radio.

I am 14 years old. It will be at least three years before I can go to war. If I could get on the air and use radio equipment and become experienced enough, I would be able to operate a radio in the army. I have my licenses, but I have never been on the air, and have not studied radio since December of '41.

Isn't there some way for us to get on the air, at least to learn?

GILES EASLEY,
 Calveat, Texas.

(Your letter stresses the nuisance of war but fails to consider the seriousness of war. If an amateur band were opened it would require constant vigilance to see whether advantage were not taken of this liberty by enemy agents, and the F.C.C. is too busy for that. Undoubtedly you can find other amateurs in your vicinity who may be able to meet with you for occasional code practice—even if it's only on an audio oscillator. You should have more time now to study the technical phases of radio and to do some experimental work which will be valuable to you later on. Perhaps your local Civilian Defense group will find use for your services, either for constructing or operating emergency transceivers.—Editor)

in the summer it is nice to have a portable phonograph to take to the beach, and I would appreciate it very much if you would give me some information on how to counteract this fault without going to more expense, as the phonograph is one of the manufacturer's most expensive portables and has already cost me a great deal of money.

HERBERT WOLFF,
 Brooklyn, N. Y.

(Assuming that the phonograph is properly leveled—two small spirit levels placed at right angles may be permanently mounted adjacent to the turntable—the fault could be due to some mechanical defect that does not permit the sound head to rest freely on the record. If the trouble you encounter is characteristic of the phonograph you have, the manufacturer's service department would be sure to know about it.—Editor)

HELP WANTED

Dear Editor:

Having read your magazine for quite some time I have seen you help a good many people with their problems. I would like to know if anyone has a diagram of the Howard "Neutrodynic," Type A, five-tube receiver. I believe it was manufactured in 1924. I will be more than glad to pay for the information.

WILLIAM M. REYNOLDS,
 301 W. Laurel Ave.,
 Lake Forest, Ill.

OHMITE
Resistance Units

are built for long trouble-free service

Send for FREE Ohmite Stock-Unit Catalog No. 18. Very handy for quick reference.

The extras built into Ohmite Resistance Units make them electrically and physically fit for the toughest service. Ohmite units, for instance, were on the planes that bombed Tokyo. They're widely used in ships and tanks, too—in communications and electronic equipment—in research and production—in training centers and industrial plants. It's well worth remembering, when you build original equipment or make vital replacements—today and tomorrow.



Send 10c for handy Ohmite Ohm's Law Calculator. Helps you figure ohms, watts, volts, amperes—quickly, easily.

OHMITE MANUFACTURING COMPANY
 4894 Flournoy Street, Chicago, U. S. A.



QUALIFY-AT HOME-QUICKLY

for your pick of the 200,000 RADIO JOBS in the Armed Forces, Commercial Broadcasting & Industry.

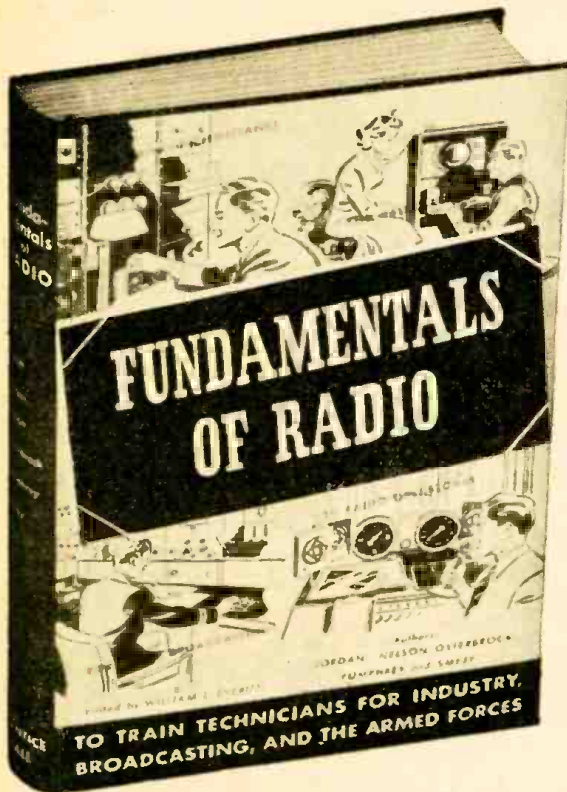

Use this Standard New Home Course in BASIC RADIO COMMUNICATIONS to brush up and meet today's requirements

If you want to prepare yourself for a radio post in advance of induction or enlistment in the military services—if you want to get into radio broadcasting or into the radio industry—here is the book that will give you the basic training you need. FUNDAMENTALS OF RADIO trains you in the entire field of basic radio communications, from the simplest circuits right through FM transmission. No previous experience is necessary. This easy-to-grasp home course is written not for engineers, but for student technicians who must know how to maintain and operate all types of radio apparatus, and have only a limited time in which to master the required essentials.

"The One Book Unique In The Radio Field"

"With this one volume alone, men with no previous radio experience or knowledge can obtain a thorough grounding in radio principles. In thoroughness, this book is outstanding . . . in the authors' appreciation of the reader's outlook and problems . . . the one book unique in the radio field."

—Scientific American.

"For many years, I've sought an adequate answer to the oft-repeated question, 'Where can I find a book which, in one volume, will teach me the fundamentals of radio?' This book is the answer I've waited years to have."

—E. K. Cohan, Director of Engineering, C.B.S.

"Anyone mastering the contents of FUNDAMENTALS OF RADIO should possess all the preliminary requirements of radio men and technicians for military and naval service."

—E. E. Tierney, Chief Instructor, Eastern Radio Institute, Boston, Mass.

COMPLETE TRAINING FOR TODAY'S IMMEDIATE NEEDS . . .
Here is a glimpse of your instruction in basic radio communications

Concise Review of Radio Mathematics—A. C. and D. C. Circuits—Power, Energy, Fuses, Batteries, Electromagnetism, Generators, Meters, Transformers, Rectifiers, Resonance Testing, Voice and Music Waves—Electronic Principles—Rectified Power Supplies—Sound and Electrical Transmission—Sound, Distortion, Microphones—Reproducers—Telephone—Loudspeakers—Audio Amplifiers—Public Address Systems—Vacuum-Tube Instruments—Oscillators—Electromagnetic Waves—Radiation and Reception—Antenna Structures—Transmission—Radio Frequency Amplifiers and Detectors—Input and Output Circuits—Amplitude Modulation Radio Transmitters—Radio, Audio Frequency Section—Crystal Oscillators—Buffer Amplifiers—Modula-

tors—Transmitter Circuit—Radio Frequency Section—Amplitude Modulation Radio Receivers—Frequency Modulation, General Principles, Wide-Band FM and Static Eliminators—FM Systems for Communication Services—FM Transmitters and Receivers—Radio Wave Propagation—Polarization—Static and Man-Made Noise—Ultra-High-Frequency Propagation—Diffraction—Refraction—Functions of Radio Antennas—Types—Directional Antenna Systems—Radio Beacons—Direction Finders and Radio Compasses.

OVER 300 WORKING DIAGRAMS
from the simplest circuit to FM transmission

With any sort of past interest in radio as a background, your chances of landing a big-pay, big-opportunity job were never so bright. In the land and naval forces, in aviation, commercial broadcasting, police airways and the manufacturing industry, the shortage of radio technicians is acute, the rewards exceptional. Now is the time to give yourself the rapid basic training in radio communications which qualifies you without delay. FUNDAMENTALS OF RADIO provides exactly that training—at home—in your spare time—without wasting effort on non-essentials—without omitting any of the essentials required in actual practice. In one handy, easy-to-master volume, written by six high-ranking instructors, FUNDAMENTALS OF RADIO covers everything you need to know about basic radio communications.

MONEY-BACK GUARANTEE

PRENTICE-HALL, Inc.
Dept. FR-6, 70 Fifth Ave., N.Y.C.

Please rush copy of FUNDAMENTALS OF RADIO. I enclose \$5, plus 10c postage. If, within 5 days, I decide not to keep this book, I am free to return it for refund of the purchase price.

NAME

ADDRESS

CITY & STATE

SEND C.O.D., plus few cents postage charges. (Same refund guarantee.)

Clip this coupon or order by letter, addressing Dept. FR-6, as above.

FREE 5-DAY OFFER

Every minute counts! Don't postpone your opportunity for a good job now and the foundation for a highly successful future in radio. Get started by mailing this coupon at once on our 5-DAY-MONEY-BACK-OFFER. Read, study, examine FUNDAMENTALS OF RADIO for five days—free. Return the book for refund if you do not find it the easiest way to qualify, at home, quickly, for one of the 200,000 radio jobs now waiting for men to fill them.



• William L. Everitt, Ph.D., Editor, Senior Consultant on Air Communication and Director of Operational Research Section in Signal Corps, U.S. Army; Professor of Electrical Engineering, Ohio State University; Fellow of AIEE and IRE; member of Board of Directors and Board of Editors of the Institute of Radio Engineers.

- Lynne C. Smeby, Consultant on Air Communication, Signal Corps, U.S. Army; formerly Director of Engineering for National Association of Broadcasting; member of Board of Editors of Institute of Radio Engineers.
- William Carl Osterbrock, Professor of Electrical Engineering, University of Cincinnati.
- Fred H. Pumphrey, Curriculum Adviser, Signal Corps, U.S. Army, Professor and Head of Electrical Engineering, Rutgers University.
- Paul H. Nelson, Ohio State University; formerly radio engineer for Westinghouse Electric, RCA Victor and other firms.
- Edward C. Jordan, Ohio State University; research work in antennas and impedance matching systems; consultant on transmitters and radiating systems.

CIVILIAN DEFENSE RADIO LICENSES GRANTED

The first licenses to be granted by the Federal Communications Commission under newly-established regulations for civilian defense radio systems have been issued by the Commission to the City of Akron, Ohio, and the City of Lawrence, Massachusetts. Classified as War Emergency Radio Service, these stations extend the organized civilian units functioning under the Office of Civilian Defense. In event of air raids or other enemy action which destroy other forms of communications, the emergency radio will be available to co-ordinate rescue and repair work.

Under the terms of the licenses granted, Akron will have a two-way low-powered radio system of sixteen receiver-transmitters. Some of these will be in fixed locations, others will be mobile and a few will be of the type known as "walkie-talkies," because the operator may use it while moving about. Lawrence, Massachusetts, has been licensed for a system of eleven two-way radios.

Applications of many other cities are now pending at the F.C.C. and requests from the different communities vary to fit local conditions. Fort Wayne, Ind., has plans for more than one hundred such sets, while Dayton, Ohio, indicates that forty radios will serve its needs. Some applications are being returned to municipalities because the forms fail to indicate what arrangements exist for liaison with Defense Commanders for the purpose of receiving orders of radio silence when conditions dictate. Regulations of the F.C.C. require that the licenses be issued to the municipal governments proper rather than to any of the departments.

Formation of the War Emergency Radio Service was announced jointly by the F.C.C. and the O.C.D. last June 13, at which time it was explained that radio amateurs, repairmen and others having sufficient experience would be asked to volunteer and serve in the operation of the civil defense radio systems. The two-way radios operate on ultra short waves with power sufficiently low to limit their range to approximately ten miles. Spare parts lying around radio repair shops are considered sufficient to construct these radios.



Mrs. James Marglin, first woman radio operator to receive an appointment to the Signal Corps, conducting a code class at the American Women's Voluntary Services school in New York City.

SIGNAL CORPS WOMAN TEACHES AWVS GROUP

A series of special code classes for a selected group of students from the American Women's Voluntary Services code course, aimed to bring these students up to sufficient code speed to qualify them for service in communications work with the Armed Forces, was begun last month at AWVS Greater New York Headquarters, in New York City.

The classes are being directed by Mrs. James Marglin, of Fort Knox, Kentucky, the first woman radio operator to receive an appointment to the United States Army Signal Corps during the present war. Mrs. Marglin, who, though only 24 years of age, is said to be one of the fastest operators—man or woman—in the Signal Corps, having a speed of 50 words a minute on the

special "mill" typewriter used for communications work. Mrs. Marglin believes that advanced AWVS code students who have a speed of 25 words a minute or over can be brought up to the required speed of between 30 and 35 words a minute in a month's intensive training.

Mrs. Marglin was invited to give the special courses for advanced students at the request of Mrs. Lenore Kingston Conn, Director of AWVS Code Instruction for Greater New York, and is conducting these classes during her five weeks' stay in New York. She entered the field of radio a few years ago because of a challenge that "women were not sufficiently intelligent to master the art of radio." Deciding to "show" her doubting male friends, she took up the study of code and within three weeks was sufficiently proficient to send and receive 18 words a minute.

Within a relatively short time she earned her Federal Communications Commission Amateur Radio Operator's License and established her own "ham" station (W9ZTU) at Fort Knox. It was over this station that she first talked with her present husband, James Marglin (W9THS), who is an instructor in communications at the Armored Force School at Fort Knox and who is now in New York with her. Although they lived only a block apart for six years, he in the army barracks, she at home, it took the air waves to bring them together. Their courtship was carried on for six months over the air before they actually saw each other face to face.

During this period Mrs. Marglin had been doing volunteer service for the government by maintaining communications on a four-times-a-day schedule between service men from Fort Knox who were out on maneuvers and their families at home. She says that it was in recognition of this service that she received her special appointment to the Army Signal Corps. Her work at Fort Knox involves handling War Department traffic, with a bit of teletype operation on the side.



Chief Metalsmith Ed Regan (U. S. Navy) receives detailed instructions on a new and secret tube-welding process from an employee of National Union Radio Corporation.

Practical Transformer Design

By FRED SHUNAMAN

This is the second of a series of articles on wartime transformer rewinding by Mr. Shunaman, whose work as a serviceman in China frequently made it necessary for him to rewind transformers for the different filament and plate voltages encountered there. His article last month described how to make coil-winding machines and gave essential information for the serviceman to follow.

MOST articles on transformers are theoretical. They deal with voltage and impedance ratios, flux fields and iron and copper losses. The would-be designer of a small transformer looks in vain for an answer to the question, "How many turns of what size wire on how big a core do I need to do such a job?" This article will attempt to answer just that question, and will leave out all theoretical angles.

Let us consider a transformer needed to supply a small amplifier. The plate supply requires 100 mls at 250 volts, the filament windings 1.7 amps at 6.3 volts and 2 amperes at 5 volts. The drop through the filter choke (or speaker field) is 100 volts, and as condenser input is used, the input filter voltage at 100 mls will be about the same as the R.M.S. voltage of the transformer secondary.

DETERMINING DESIGN FACTORS

The first step is to make a diagram of the proposed transformer, putting down the voltages and amperages of each winding, and filling in other facts as we find them. (See Fig. 1.) So far, we know the number of windings and the voltages and currents required from each one. If we multiply volts and amperes together we arrive at the number of watts we expect our transformer to put out—in this case about 55 watts.

The core material is our first problem. Fig. 2 says we need a core a little bigger than 1½ inches in cross-section. As our work must be done with junked material, we can not expect always to get just what

we're looking for, so bear in mind that too big a core will—within limits—both improve the performance and make winding easier. A bigger core requires less wire and has a larger window, so if wire of the correct size can not be found, a larger size can be used, again with an improvement in performance. Too small a core invites disaster.

SQUARE CORE IS PREFERABLE

Let us assume we had a large transformer with a core 1½ inches wide (the width of the center bar of the "E" piece), enough laminations are taken to make a core 1½ inches square. This is a little bigger than we need, but the square core, besides being preferable electrically, is the easiest for which to wind a coil. The window is 2½ by 11/16 inches. It now remains to determine if we can get the necessary wire onto it.

First, we must have a large enough number of primary turns properly to magnetize the core. The usual rule for this size transformer is

$$\frac{7.5 \times \text{voltage}}{\text{core area (sq. in.)}}$$

commonly stated "7.5 turns per volt." Our core is almost 2 square inches in area, therefore the turns ratio is 3.75 per volt. Now we can proceed to fill in our diagram further. 110 x 3.75 gives us 412.5 turns. Similarly, the secondary will need roughly 1350-1350 turns, the 6.3-volt filament 24 and the 5-volt filament 19 turns. The figures as calculated are 1312.5, 18.75 and 23.6, being

FIG. 11
SIZE OF TRANSFORMER CORE FOR OUTPUT WATTAGE

Volt-amps Output	Core size (Sq. In.)
25	1.0
50	1.5
75	1.75
100	2.0
150	2.5
200	3.0
250	3.5
350	3.75
500	4.0

These sizes are generously calculated and allow ample regulation.

rounded up for convenience and to help overcome any voltage drops due to resistance. It is also well to add about 5% to all filament windings; in our case one turn added to each low-voltage winding should be enough to compensate for the resistance drop (voltage loss due to the ohmic resistance of the wire).

CURRENT RATING GOVERNS WIRE SIZE

Figure 3 shows us the correct size of wire for each current rating. As almost all transformers of this type are wound with enamel-covered wire, it was thought unnecessary to show figures for other kinds of insulation. For intermittent use—as in radios—the rule is to allow 1,000 circular mils to each ampere. We find that the half-ampere drain in the primary requires No. 23, the secondary No. 30 and the two filament windings Nos. 18 and 17, respectively. (In transformers designed to run 24 hours per day, 1,500 circular mils per ampere may be allowed.)

Since only half the secondary is carrying current at any time, we can cut down the wire size. We will use No. 31, a cut of 20% in the carrying capacity, though we could cut it as much as 1/3 if necessary. Economics can also be made on the filament windings, for being near the outside they have a better opportunity to dissipate heat than the primary or secondary. We will use No. 18 instead of No. 17 for the rectifier filament. It is rated at only 1.6 amperes at 1,000 C.M. per ampere, but can carry 6 amperes in open air. The filament winding just inside it can be cut down a little, too, using No. 19, rated at 1.3 instead of 1.7 amperes.

CHECKING FOR WINDOW SIZE

Now that we know just about what we can use, we have to find if we can get this amount of wire in the window.

Referring to Fig. 3 under "Turns per square inch" we find:

412 turns of No. 23 occupy 0.24 sq. in.
2700 turns of No. 31 occupy .26 sq. in.
Filament windings .22 sq. in.

The filament windings in this case were calculated by allowing 1/16 inch for each

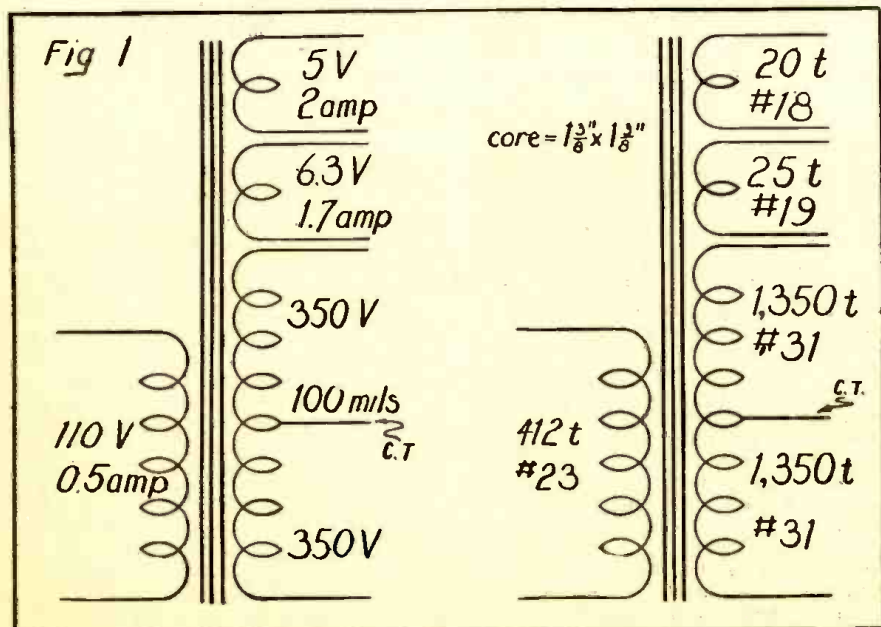

RADIO-CRAFT

Incorporating

RADIO & TELEVISION

"RADIO'S GREATEST MAGAZINE"

DEADLY RADIO TRANSMISSIONS

By the Editor — HUGO GERNSBACK

. . . *The Axis Radio Agents must be eliminated . . .*

WE have found it necessary to speak from time to time of the real peril confronting the United States, due to the activity of Axis agents, who operate secret radio transmitters in the United States and its territories.

This is all quite ancient stuff and, as often before, history merely repeats itself.

I probably was one of the first to point this out, even before the First World War got under way, when the then Imperial German Government—even before the United States entered World War No. 1—succeeded in sending valuable information from the United States to Germany.

At that time, the German Telefunken Company had erected on Long Island a transmitter known as the Sayville Station.

In my former publication *THE ELECTRICAL EXPERIMENTER*, (August 1915 number), I pointed out that secret messages could no doubt be sent out over this station, violating the neutrality of the United States. It will be remembered that the director of the station went to great pains to denounce me, in no uncertain terms, for the publishing of such a "fantastic story." Yet before the ink was dry, phonograph records had been made showing that the station actually had sent out high-speed signals, interspersed with the regular signals, which could not be detected by the normal ear; but by recording these signals on a phonograph record and then slowing up the record, the secret messages became clear. Subsequently, the United States Government took over the Sayville Station and thus prevented secret messages from going out over that channel.

In the present War, when there is a super-abundance of radio stations and facilities all over the country, it becomes much simpler for the Axis agents to use their ingenuity in trying to get information out of the United States.

Troop and ship movements particularly, in the very nature of things, must be transmitted speedily if the enemy is to get any advantage. The telegraph, telephone and cables are pretty closely watched, and such slow means as the mails cannot be considered.

The agents who are charged with the transmission of important information must be resourceful; they also must be good radio technicians, if they are to succeed at all. This makes the problem all the more complicated for our authorities. No foreign agent would be foolhardy enough to operate a fixed transmitter.

Taking a leaf from the book of our own bootleggers—who operated mobile transmitters during prohibition—Axis agents necessarily will use only such mobile transmitters. When located in automobiles or trucks they can be moved rapidly from point to point and it becomes a problem of the greatest magnitude to locate and apprehend the men who operate such transmitters. As the agents for obvious reasons, use short waves almost exclusively, their problem is simplified too, because such equipment weighs little and can be readily concealed in an automobile, truck or motorboat.

There has been a movement in this country to prohibit the sales of all radio parts and accessories because it was thought that this would stop the assembly and manufacture of such illegal spy-transmitters.

Such a course would be the height of foolishness, because any radio man, even without being a brilliant technician, can easily assemble a good transmitter from junk radio receivers. It thus becomes not only impossible but quite impractical to stop any wilful agent from plying his trade if he so chooses.

It often takes quite a while before a mobile transmitter can be run down, but we believe that sooner or later the majority of them will be apprehended.

The F.C.C. recently reported that approximately 100 monitoring stations have been set up during the last few years in order to stamp out the illegal short-wave transmissions from the United States. These stations not only search out the illegal stations themselves, but they analyze suspicious communications and unknown sounds as well. But we should realize that the monitoring of all the multitude of wavelengths day and night is a tremendous undertaking, and while recordings are made of every transmitter on the air—located not only in the United States but of every transmitter in the entire world (which can be heard in this country)—I believe also that something more is needed, if we are to cope successfully with the menace.

It has been suggested many times that amateurs should monitor as many wave lengths as possible and report immediately any suspicious-sounding transmission to the proper authorities.

The trouble with this plan is, that so far such listening posts to the best of our knowledge have not been organized in such a manner that every section of the country would be under constant surveillance 24 hours a day. In each section of the country there should be listening posts monitoring continuously certain wavelengths and no others. This in itself would be a huge undertaking but it is believed that only in this manner full safety can be realized during the long war which we are certain to have.

Nor will it be satisfactory to have even expert amateurs and listeners just "listen in". It is more important that there be a record of each emission, and this means high-grade equipment which few amateurs possess.

Instead of only 100 F.C.C. monitoring units, we really need between 1,000 and 3,000 such posts, scattered all over the country and in our territorial possessions as well. In my estimation, trained radio amateurs, of which there are many thousands, and particularly men above 40 years who have been amateurs, could be sworn in by the Government for a listening-monitoring network with only one purpose in mind to account for all illegal transmissions that may emanate from the United States. The problem is further complicated by what is known as the skip-distance effect, whereby short-wave emissions are not heard at all in the immediate vicinity, and for that reason such stations are best monitored from a distant point, or points. With such a listening-monitoring network, mobile enemy transmitters could be watched and located much more readily than is the case now. *The principle that it is easier to catch a fox with a dozen dogs, than with two, holds good in radio as well.*

Finally, I wish to go on record once more and repeat what I have said numerous times—that I believe illegal messages can readily be sent out over our small foreign-language stations of which there are too many in this country and territories now. The possibility of sending out secret intelligence through the means of an innocent violin or piano or other music solo should be apparent to every one.

The foreign-language stations are a powerful magnet to every Axis agent who would like to try his hand on a new and fanciful code, that can be sent out easily by radio performers without too much danger of being apprehended. *It is here that our greatest vigilance should be centered for the duration.*

A Digest of News Events of Interest to the Radio Craftsman



RADIO EQUIPMENT FOR THE WAR AT SEA

Long rows of radio transmitting equipment for the Navy are shown here in one of the vastly expanded factories of General Electric's radio, television and electronics department. Many warships have not one but a number of transmitters and receivers of various frequencies and power. They carry also equipment for detecting enemy planes and ships as well as portable radio equipment for various uses. Besides making radio equipment for the armed services, General Electric is conducting courses in its care and use for many military and civilian technicians in government service.

"TEMPORARY" FM STATIONS TO GET WARTIME LICENSES

Because war conditions have caused great shortages in materials, equipment and skilled personnel necessary to radio broadcasting, the Federal Communications Commission has announced that holders of construction permits for new frequency-modulation (FM) radio stations may obtain licenses during the war to operate presently existing facilities, provided construction has reached a point where the transmitter is presently capable of being operated to render a substantial public service. FM broadcasters obtaining licenses under this policy will have to show that additional construction is not possible at this time and they must assure the Commission that construction will be completed according to the rules, regulations and standards of the FCC as soon as the required materials and engineering personnel become available.

According to FCC records there are 5 licensed FM stations now in operation. Twenty-three stations are operating under special temporary authorization pending completion of construction in accordance with the construction permits. Upon appropriate application these would receive licenses to replace the special temporary authorizations. An additional 7 stations are now conducting program tests and have filed applications for operating licenses. The new policy under which the FCC will consider applications for operating licenses on the basis of partial construction probably will affect also 21 other holders of FM construction permits. Six permittees now building studio transmitter links, which

connect with station transmitters would come under the policy. Applicants for new facilities, however, are barred, except under special circumstances, by an earlier "freeze" policy announced in April, which recognized the necessity for conserving critical materials and banned new grants for FM as well as most other types of broadcast radio.

The commission observed that the Communications Act does not contemplate extensions of time within which to complete construction unless it appears that construction can be completed within a reasonable length of time. Nor is it desirable to continue the issuance of special temporary authorizations upon a short-term basis. However, it is desirable to encourage such service as is now possible to listeners having FM receivers. Accordingly, the commission will give consideration to applications for licenses to cover partial construction of FM and ST (studio transmitter) stations where such construction has proceeded to the point where it is possible to provide a limited but satisfactory FM service. The commission will also consider applications where construction has been completed and the permittee has been unable to obtain equipment and technical personnel to make measurements, required as a prerequisite to issuance of a license. Such licenses will be granted on the definite understanding that as soon as the required materials and personnel are available, steps will be taken to comply fully with the original construction permit.

NEWS FROM FM CENTERS

CHICAGO—Some of FM's best tributes have come from some of the nation's finest musicians. Stravinsky, Koussevitzky, Deems Taylor, Stokowski and others have commented on the tonal qualities of FM. Among the latest laurel wreaths is a remark by Felix Borowski, one of the country's top musicians and composers who is also professor of music at Northwestern University.

After hearing a piano concerto over W59C, The Chicago Tribune's FM outlet, Dr. Borowski declared: "Frequency modulation is an answer to the prayer of music lovers who have longed—and many of them have spent years in longing—to hear musical instruments as they really are.

"The greater fidelity of certain instruments under the new system has to be heard to be believed. This, it appears to me, is particularly noticeable in the case of the piano, whose tone with frequency modulation is not only a true reproduction of the original sound but often takes on a well-rounded singing quality that may not have been present in the performance that is broadcast. Altogether, I am convinced that the new system has a great future before it."

MILWAUKEE—FM is becoming quite a husky youngster in the radio world around these parts. According to figures obtained by W55M, The Milwaukee Journal's 50,000-watt FM outlet, following a recent comprehensive study, there were—as of June 1—a total of 16,230 FM receivers in the 8,540 square miles which make up the W55M service area. These figures tally closely with those issued by FM Broadcasters, Inc., FM's national trade association, which indicate 13,000 FM sets in the city of Milwaukee alone. This amounts to an increase of more than 75% over totals shown in a similar study made last Fall.

PHILADELPHIA—The unique color and sound film—"Listen! It's FM!"—produced last fall by the General Electric Company to explain and illustrate the merits of frequency-modulation broadcasting, is now making the rounds of Philadelphia schools as an educational feature. Roger W. Clipp, general manager of W53PH (operated by WFIL), was so impressed recently with the instructive qualities of the film that he invited the entire Philadelphia Board of Education to view it. They concurred with his opinion, and Philadelphia school children are now learning what FM means in terms of better radio reception.

COLUMBUS, Ohio—W45CM in this city, Ohio's pioneer FM outlet, has encountered what it believes to be the ultimate in listener loyalty. The owner of a new FM receiver, so pleased with the purity of FM reception, called up the station and offered to donate money if it should ever be needed to keep W45CM on the air! The gentleman's generosity was politely declined, of course, but W45CM says the incident shows how much the public appreciates and approves of noise-free, full-fidelity broadcasting.

CBS MOBILE TELEVISION PERMIT

Columbia Broadcasting System was granted modification of its construction permit for a new portable mobile television relay broadcast station, W2XCB. Completion date was extended from July 7, 1942, to January 7, 1943.

COPPER WIRE TABLE—ENAMEL INSULATED WIRE

Fig. 3

B. & S. Diameter (A.W.G.)	Diameter M.M.	Diameter Mils	Circular Mils (Bare)	Turns per in.	Turns per sq. in.	Feet per lb.	Ohms per 1000 ft.	Carrying Capacity (amperes)		Nearest S.W.G.
								1000 C.M./amp.	1500 C.M./amp.	
14	1.67	65.9	4107	14	182	69.4	2.575	4.1	2.7	16
15	1.49	58.8	3257	16	240	100	3.247	3.3	2.2	17
16	1.33	52.4	2583	18	310	126	4.094	2.6	1.7	18
17	1.19	46.9	2048	21	397	159	5.163	2.0	1.3	18
18	1.06	41.8	1624	24	493	201	6.510	1.6	1.1	19
19	.95	37.4	1288	26	592	253	8.210	1.3	0.86	20
20	.848	33.4	1022	29	825	319	10.35	1.0	.68	21
21	.76	29.9	810	33	1100	402	13.05	.81	.54	22
22	.678	26.7	642	37	1380	507	16.46	.64	.43	23
23	.605	23.8	510	41	1725	639	20.76	.51	.34	24
24	.54	21.3	404	46	2160	805	26.17	.41	.27	25
25	.482	19.0	320	52	2715	1010	33.00	.32	.21	26
26	.431	17.0	254	58	3425	1280	41.62	.25	.17	27
27	.386	15.2	202	64	4300	1610	52.48	.20	.13	29
28	.35	13.6	160	72	5410	2030	66.17	.16	.11	30
29	.309	12.2	127	82	6730	2550	83.44	.13	.084	31
30	.274	10.8	101	91	8475	3220	105.20	.10	.067	33
31	.246	9.7	80	100	10425	4050	132.70	.079	.053	34
32	.223	8.8	63	113	13000	5120	167.30	.063	.042	36
33	.198	7.8	50	127	16550	5430	211.	.050	.033	37
34	.175	6.9	40	143	20500	8160	266	.039	.026	38
35	.155	6.1	32	158	25500	10200	335	.032	.021	38-39
36	.140	5.5	25	175	31800	12850	423	.025	.017	39-40
37	.124	4.9	20	198	39800	12690	533	.020	.013	31
38	.112	4.4	16	224	49200	20500	673	.016	.010	42
39	.0965	3.8	12	248	62500	25800	848	.012	.008	42
40	.0862	3.4	10	282	77000	32573	1069	.009	.006	44

All figures with the exception of Circular Mils, are given for Plain Enamelled copper wire. M.M. stands for millimeters, mil for 1/1000 inch. S.W.G. is British Standard Wire Gauge.

for the full length of the winding, as each will take up one layer in this job.

If we add 25% for insulating paper, the total area of our winding will be about 0.90 sq. in. The core window is 2 1/4 by 1 1/16 inches—at first glance amply large. But we must allow 1/8 inch for the core piece and to insure ample clearance around the core, and at least 3/16 inches at each end, so that our windings may be short enough to permit insulation and clearance at the window ends. This brings our window size

down to 1 3/4 by 7/16 inch, or just a trifle over a square inch, and leaves us a clearance of 10%.

If the winder has already tried his hand at a few old transformers, he can go ahead, certain that his windings will be smaller than estimated above. Otherwise he would be well advised to increase his 10% leeway to about 25% by using a few more laminations, and cutting down the number of turns per volt. For example, if he makes his core 1 3/4 x 1 3/4, he can wind at 3 turns per

volt, which should give him plenty of extra space. How to do the winding was described in the previous article, which appeared in Aug.-Sept. *Radio-Craft*.

Output and audio transformers are wound to a different set of rules. Generally the design is based not on watts output and voltage ratios, but rather on such factors as impedance matching, frequency response and core losses. Should *Radio-Craft* readers be interested, a future article will be printed to cover this subject.

OHMITE EXPANDS FACILITIES FOR STANDARD PRODUCTS

WORLD WAR II found Ohmite Mfg. Co. producing units of vital importance to industry and the Armed Forces—rheostats, resistors, and rotary tap switches. Conversion was unnecessary. Increased production, however, was imperative.

The completion of a large addition to the factory doubled the production space available. The moving of whole departments at a time into the new building was worked out in advance so as to permit the transfer without the loss of a single production day. Recently another nearby building was acquired which added fifty percent more production space. Besides utilizing the additional space to step up production, a night shift has kept the windows of the plant blazing with light for many months past.

Planes, tanks, ships, communications and

industry—all have received the increased output of this company's expanded facilities. Devoted exclusively to the manufacture of rheostats, resistors, tap switches and chokes, Ohmite is well able to supply the needs of industrial, aviation, radio, electronic, and scientific manufacturers, radio jobbers and others. Everything possible is being done under present conditions to work with jobbers in promoting present markets. Jobbers in many areas are serving industrial experimental, development, and maintenance needs. Also, they are serving essential requirements of local training centers and schools.

A most unusual aid to the war effort has been provided by the Ohmite Ohm's Law Calculator. This handy little device has been distributed in large quantities to men

in training, especially in Signal Corps and aviation schools, at a nominal price of ten cents. From all reports, this calculator is doing its part well in the war effort.

This company and its employees are proud to have a vital part in the arming of our country. In still another way these workers have shown their patriotism—the Minute Man flag showing more than 90% co-operation in the War Bond drive, flies over the factory.

Ohmite has not forgotten the future. When the war is won, its products will again serve every need of industry and individuals. Present development work and enlarged facilities are expected to permit even better service in the future than the noteworthy service it has provided in the past.

Analysis and Alteration of an Analyzer

By TED POWELL

THE owner of high-grade test equipment generally is reluctant to make any constructional or wiring changes in his equipment because of the voiding clauses contained in the manufacturer's guaranty.

The chances of failures directly attributable to any possible manufacturing defects, however, are small indeed, and the radio man who finds need for expensive equipment usually can take care of these occurrences himself or can afford specialized factory repairs where necessary. Therefore his desire to make revisions for the purpose of increasing the utility of his instrument carries with it only the slight element of chance regarding the guaranty.

Analizers of the class to be described are engineering developments, and the suggestions for changes should not be interpreted as criticism of the original design. Rather, it should be understood that the alterations—in this case on the Weston 772—and de-

sign suggestions were prompted by the type of service work the writer has been engaged in, and the circuit analysis is given in the belief that other servicemen might use it as a guide either for alterations or for a better understanding of the same or similar instruments.

The first operation consisted of some cabinet-making work. The analyzer comes in an enclosed type of portable case typical of laboratory equipment. While this style of case has its advantages where portability is concerned, it is something of a handicap in bench-work testing. The inconvenience lies in its cumbersome size and the greater handling effort required, a point which must be seriously considered where continuous day-long checks must be made.

The panel which supports all the analyzer components (except the C batteries) was removed from the case and the small compartment above the meter panel was unceremoniously amputated with a fine cross-



cut saw. The cut was made as close to the partition wall as possible so that the saw teeth just cleared it. The three-walled ridge that was left was then planed down and finished off flush with the partition wall with a fine rasp and sandpaper. The wood surface was touched up with thin coats of shellac and lacquer, each rubbed down and polished when dry.

This partition wall was made to serve as the new bottom of the analyzer case. The manufacturer's tag and all the hardward was removed. Wood screws were replaced where necessary to fill up old screw holes. The case handle was mounted at the new top of the case and the manufacturer's tag screwed down into place in the center beneath it. The eight rubber toes were reset at the corners of the new bottom and the new shortened back. The toes on the bottom are for rapid readings in a vertical meter position and those at the back are for more accurate checks in a horizontal position. A meter's zero set and general accuracy is somewhat better in a horizontal position because of better meter movement assembly balance in this position. The old case cover was discarded.

The photograph shows the simple case alteration plainly enough so as to obviate the necessity for any diagrams. The result is a trim-looking, open-faced, bench-type analyzer.

In the writer's short experience with industrial and radio analyzers which have had to withstand constant and hard usage (various industrial and radio analyzers aboard U.S. Naval warcraft, for instance) the small potentiometer type wire-wound resistor used for zero-setting the ohmmeter ranges for variations in battery voltage were found to be too light to stand up under punishment. The designers apparently figure the resistor size on a wattage basis rather than on a mechanical-wear basis. The net result is worn shafts, shaft bushings, rheostat contact arms and resistance elements. This results in a wobbly knob and erratic control over the meter needle when attempting to zero-set the ohmmeter ranges. This can be a considerable time-wasting nuisance where many accurate low-ohmage readings must be taken on more than one range. As a result, the small 15,000 ohm potentiometer was replaced by a heavier 2-watt unit which just cleared the case's inner wall. The shaft bearing surface was oiled lightly to prevent excessive wear.

The analyzer wiring, as is the case with nearly all such equipment, was laced with beeswaxed cord in the familiar "roll" and

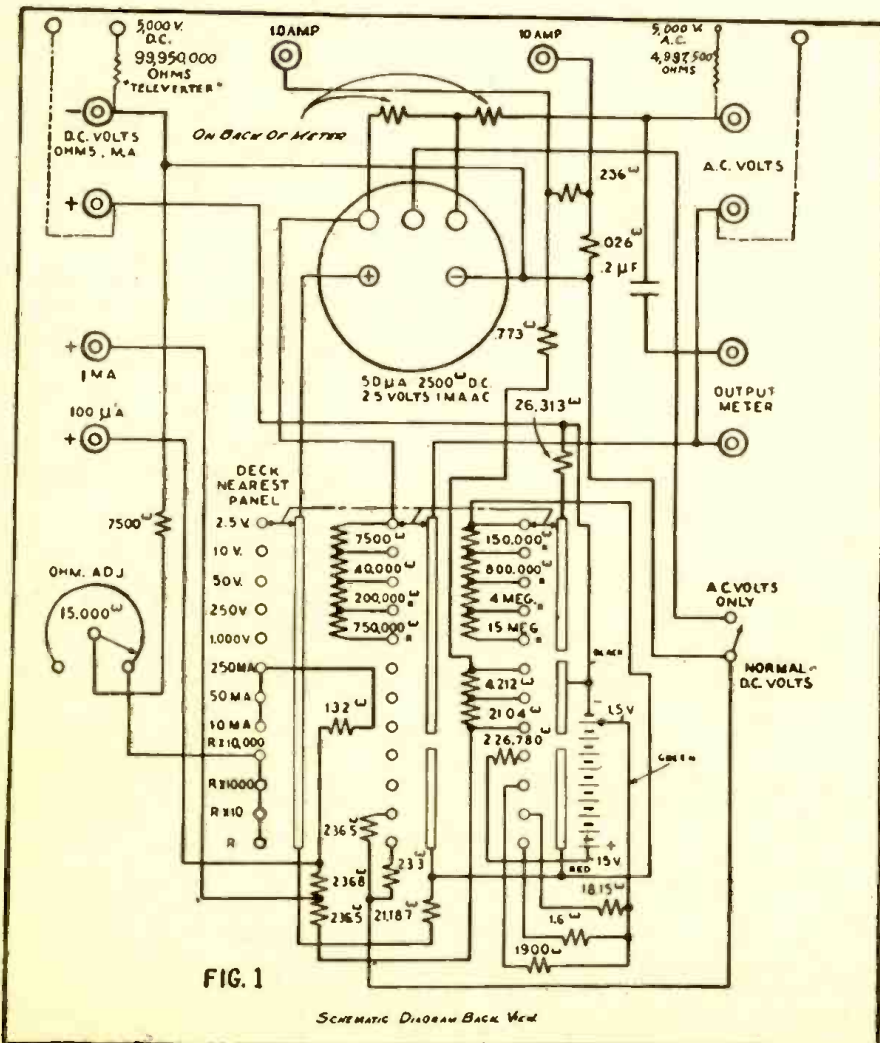

FIG. 1

SCHEMATIC DIAGRAM BACK VIEW

"lock" stitches. The lacing was drawn tightly as is the best practice in order to produce neat looking forms. Although this may look pretty, it is not very beneficial from an insulation point of view. The meter movement is a highly sensitive 50 μ a. unit and its readings will be appreciably effected by small leakage currents. The thinly insulated hook-up wire pulled tightly together by the lacing can cause trouble where moisture-laden air or chemical fumes are present, salt-sea air aboard ship or fumes in an industrial plant. All lacing was carefully clipped away with a pair of manicuring scissors. The formed wires held their shape fairly well without the supporting lacing cord anyway.

The A.C.-D.C. switch was replaced by a high-voltage rotary switch and a knob was purchased from Weston to match the ohmmeter zero-set knob. The knob was set so that the white indicator on the knob swung to equidistant positions from the A.C.-D.C. markings on the panel. This too is a minor alteration but it results in an improvement in the appearance of the analyzer.

Since the analyzer was to be used as laboratory equipment (although strictly speaking it is not), some minor resistor replacements were made. Looking at the wiring diagram (Fig. 1), it can be seen that the two banks of resistors starting with the 7,500- and 150,000-ohm pair and ending with the 750,000-ohm and 15-megohm pair, constitute the voltage-range multiplier section. The left bank is the A.-C. section and the right the D.-C. section. The 200,000, 750,000, 800,000, 4 meg-ohm and 15 megohm units are carbon resistors. The 200,000, 750,000 and 800,000 ohm units were replaced with IRC Precision 1% wire-wound resistors. Wire-wound units in the 4- and 15-megohm sizes are impractical because of the excessive size, insulation difficulties and great costs involved. Besides, such resistors would have to be specially made and this is out of the question in times such as these with a war to be won and priorities governing nearly all production. Therefore, metallized Type F IRC resistors were ordered in a 1% tolerance rating for these two ranges.

One tenth of 1% precision resistors were considered, but since the meter calibrations and the various resistors in the analyzer are held to within one or two per cent limits, this is unnecessary.

The 7,500-ohm resistor in the zero-set leg in the ohmmeter circuit was replaced with a 1% wire-wound unit, but this change

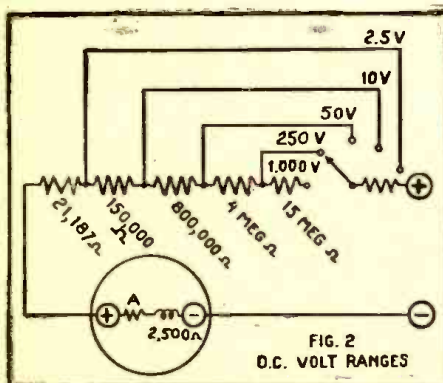

FIG. 2 D.C. VOLT RANGES

obviously is not essential. One happened to be on hand (it sells for about 60c) and it was installed, leaving only two resistors in the analyzer which were not wire-wound.

SIMPLIFIED CIRCUIT ANALYSIS

It is interesting to break down the various analyzer circuits in an elementary fashion, analyze the methods by which they are obtained, and attempt to set up theoretical values of circuit components necessary for new ranges not incorporated in the analyzer. We might begin with the voltage ranges since they are the least involved.

The D.-C. ranges when isolated and rearranged a bit, become the equivalent of the circuit shown in Fig. 2. If we check the 2.5-volt range, we find a series of resistors whose values are 26,313, 21,187 and 2,500 (meters) ohms for a total of 50,000 ohms. The meter is rated at 50 μ a at .125 volts with an internal resistance of 2,500 ohms. According to Ohm's law, we get a check on our circuit tracing operations. Thus, 2.5 volts divided by 50,000 ohms gives us 50

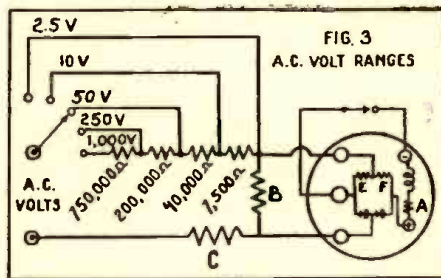

μ a, which is what the meter should draw at full-scale deflection. Making up a simple chart for the D.-C. volt ranges we get the result shown in the chart, which includes all the analyzer ranges.

The A.-C. volt ranges are shown in Fig. 3, in which are drawn the complete meter circuits omitted in the analyzer circuit diagram for the sake of clarity. Resistor A is a series adjusting spool for accurately setting the total meter circuit resistance to 2,500 ohms. Resistor B is a current-sensitivity and temperature-compensating spool for controlling the over-all A.-C. temperature characteristics of the meter circuit. Resistor C is a full-scale adjustment spool adjusted at the 2.5 volt range for exact full-scale deflection at 50 μ a. Resistors D, E and F are the rectifier load units and also auxiliary temperature-compensating resistors. Each analyzer's meter circuit is carefully adjusted at the factory under temperature-control conditions by means of spools A, B and C and therefore the exact values of these resistance spools will vary somewhat. However, in analyzing the A.-C. volt ranges, the effects of the rectifier and other resistances will be ignored except for the fact that the meter sensitivity is only 1,000 ohms per volt at these ranges.

This is a point that must be borne in mind since we now have a rectifier circuit included in the meter circuit. Meter sensitivity no longer is 20,000 ohms per volt but is 1,000 ohms per volt. The total meter current drawn now is 1 ma for full-scale deflection instead of 50 μ a. Ignoring the effects of the various compensating resistors, which are minor in their nature, we can set up a simple chart for the A.-C. volt ranges similar to the D.-C. ranges. (At these A.C. ranges the meter "resistance" is still 2,500 ohms but at a sensitivity of 1,000 ohms per volt at 1 ma at 2.5 volts.)

Both volt-range charts can be used to make simple alterations of the analyzer circuits. Suppose a 500-volt A.-C. range were desired (one used in radio service work with some frequency), and a rotary switch with more than 12 positions were available. A total circuit resistance of 500,000

ohms would be required to obtain this range, since 500 volts divided by 500,000 ohms equals 1 ma. This total resistance would be distributed between the meter circuit and multiplier sections: 497,500 ohms in the multipliers and 2,500 ohms in the meter circuit. This would be obtained in a 250,000, 200,000, 40,000, 7,500, and 2,500 ohm (meter) arrangement. The 1,000-volt range would then have its own sectional multiplier of 500,000 ohms instead of 750,000 ohms to maintain the necessary total multiplier resistance of 1 megohm. In other words, the 1,000-volt sectional multiplier has in effect been tapped at 250,000 ohms to obtain the extra 500-volt range and thus tap has been obtained by replacing the 750,000-ohm unit with two equivalent resistors of 250,000 and 500,000 ohms each. The new circuit for the 1,000-volt range would be 500,000, 250,000, 40,000, 7,500 and 2,500 ohms for the required total of 1 megohm (1 megohm divided into 1,000 volts equals 1 ma.). See diagram 3.

In a similar fashion a 500-volt D.-C. range can be set up in 5 megohms, 4 meg-ohms, 800,000 ohms, 150,000 ohms, 21,187 ohms, 2,500 ohms (meter) and 26,313 ohms for the necessary 10 megohms. (500 volts divided by 10 megohms equals 50 μ a.) The new 1,000-volt D.-C. range would then be in a 10-megohm, 5-megohm, 4-megohm, 800,000-ohm, 150,000-ohm, 21,187-ohm, 2,500-ohm (meter and 26,313-ohm set-up for the required 20-megohm total. (1,000 volts divided by 20 megs equals 50 μ a.) See diagram 2.

Thus by applying Ohm's law we can set up any desired volt ranges.

Figure 4 shows the D.-C. current ranges rearranged and simplified a bit. The process of isolating these current ranges is complicated slightly by the fact that the lighter current ranges are selected by the selector switch and the heavier current ranges by the jacks and two smallest current are selected by jacks, rather inconsistently. However, upon some simplification, we get the simple series-shunt affair shown in Fig. 4A.

If we take the 1 ma. range for an example and set up a still further simplified network, we get a shunt leg containing a meter resistance of 2,500 ohms, a resistance of 2,500 ohms in series with it and a paralleling shunt leg of 262,787 ohms in parallel with it. Remembering that a full-

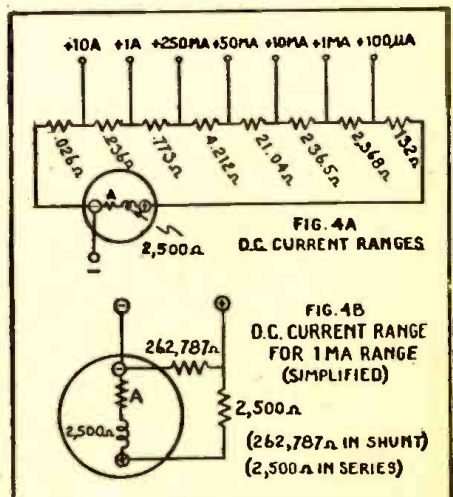

scale meter deflection requires 50 μ a. or .125 volts, we know that a voltage drop of .25 takes place across the meter-resistor (Continued on page 58)

TRACKING DOWN GRID EMISSION

Causes and Cures for a Trouble-Making "Bug"

AMONG the many "bugs" that find their way into a radio circuit, there is one that has caused untold grief and confusion to the serviceman. Its common name is GRID EMISSION.

Although it starts life as a tiny electron, it soon grows to huge proportions. It is elusive in its ways, and much valuable time may be lost merely in determining its presence. After that, more time is consumed in solving the serious problems that it creates. No doubt, you are familiar with some of the following complaints: blocking, loss of sensitivity, lack of selectivity, distortion, burned out plate and screen resistors, low emission rectifier and power tubes, and hum. These are a few of the problems of grid emission and they are generally reported to take place after the receiver has been in operation long enough to become overheated.

Perhaps you have tested tubes, condensers and resistors, yet you found everything to be normal. Try though you may, you have never located the cause of these complaints, although you may have effected a cure by the cut and try method. Of course, you know that the cathode of a radio tube is designed to emit electrons; but this is not true of the grid. Grid emission, as the name implies, means that the GRID gives off or emits electrons. When electrons flow there is also a flow of current, (as can be seen if we place a milliammeter in series with the cathode) and current flowing through coils and high value resistors in the grid return circuit, will produce a voltage drop detrimental to good circuit performance.

Why do we have grid emission? Well, during the process of evacuation of a radio tube a small portion of the cathode emitting material is sometimes unavoidably splashed on to the grid with the result that should the grid become sufficiently heated during operation, it will emit electrons.

To reduce this disturbing effect every precaution is taken in the design of Sylvania radio tubes to keep the grid as cool as possible. Copper grid supports are used because copper, being a good heat conductor, carries the heat away from the grid. Grid radiators are attached to the grid to give a greater heat radiation area. Colloidal

graphite is sprayed on plates and bulbs to increase the heat radiation to the outside away from the grid,—all to keep the internal tube structure cool.

We conclude, therefore, that excessive heat is the factor that must be avoided if we are to keep away from grid emission.

More recent tube types are of higher mutual conductance than those of the earlier days and in order to obtain this increase in mutual, the spacing between the grid and cathode has been greatly reduced. As a result, the grid is close enough to the cathode so that excessive heater voltage, or cathode current will heat the grid to the emission point.

Another recent factor aiding the evil of grid emission is the trend toward the zero-bias type of receiver operation. In this type of circuit the DC resistance in the grid returns are generally very high. This results in a higher disturbing-voltage drop, and at the same time fails to produce a negative bias voltage which would be helpful in opposing the disturbing voltage.

The r-f circuit shown in Fig. 1 represents a typical zero-bias arrangement which we will use to follow the actions of grid emission.

Let us assume that the initial bias on the tubes derived from the contact potential of the diode is -1 volt. We will also assume that the receiver has been in operation long enough to become sufficiently over-heated to stimulate grid emission. The excessive heat may be caused by improper ventilation, high line voltage, or the exceeding of the voltage ratings of the tubes.

The grid of any one of the tubes, being overheated, will now give off electrons and current will flow. To start with, this current is very very small, being only about one microampere. However small though it may be, it must return to ground. Therefore, it flows through the r-f coil, through the A.V.C. resistor R, on through the volume control to ground. During its course to ground the current had to pass through the A.V.C. resistor R whose value is three megohms, and, according to Ohm's law, current flowing through a resistance must produce a voltage drop. As $E=IR$ we then have a voltage developed across R equal to 3 volts. The polarity of this voltage

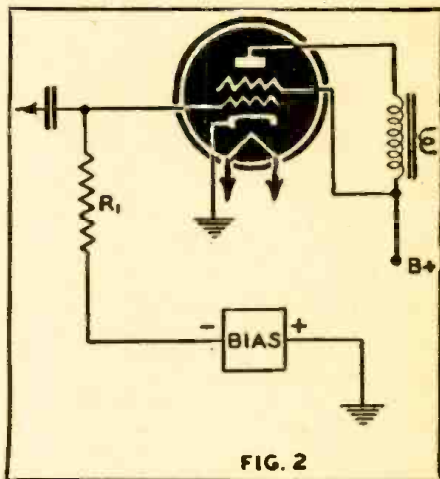

FIG. 2

drop is the HARMFUL factor. Current flowing from the diode to the grid produces a negative voltage at point X, but current going from the grid to ground produces a positive voltage. Therefore, at point X we have +3 volts developed by the grid current flow, minus the -1 volt of bias caused by contact potential, leaving a +2 volts. This means that at the grid of each tube on the A.V.C. string, there are 2 volts of positive voltage! You and I know that we cannot use positive voltage on control grids. It must be negative!

With positive voltage on the grid, the plate current increases, causing more heat within the tube, thus liberating more electrons from the grid. This continues in a vicious circle until the positive voltage at the grid becomes high enough to block the tube. Plate and screen resistors may burn out, rectifier tubes are overloaded, and sensitivity falls off, due to the change of characteristics brought about by grid emission.

Fig. 2 represents a typical power output stage. Here grid emission is more troublesome, due to the greater amount of heat generated within the power tube. The grid current flowing in R₁ can become sufficiently high to cause enough positive voltage to cancel out the negative bias thereby producing bad distortion. At the same time the resultant heavy plate current will in a short time liberate gases from the over-heated elements. With the ionization of the gas the cathode is bombarded by positive ions and its emission is destroyed.

To prevent the possibility of such destructive effects, tube manufacturers issue specifications as to the maximum permissible voltage ratings that may be applied to each tube, also the values of permissible DC resistance in the grid-cathode circuit. These values must be adhered to at all times for satisfactory tube operation.

The effects of grid emission are to some extent minimized by the employment of automatic or self-bias in which grid bias is derived from a resistance in the cathode or filament return. An increase in plate current tends to increase the effective negative bias applied to the grid, thus opposing the cumulative effects of the positive voltage caused by grid emission.

(Continued on page 50)

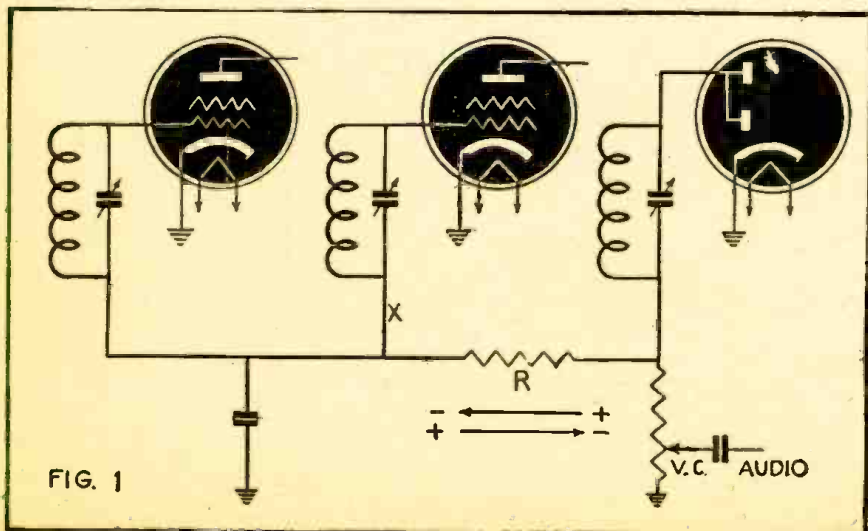

FIG. 1

TESTING SMALL POWER TRANSFORMERS

By H. R. HEAP

THE following simple tests can be carried out by the average amateur without the use of complicated apparatus.

- (1) Voltage ratio
- (2) Temperature rise
- (3) Polarity
- (4) Iron loss
- (5) Copper loss
- (6) Regulation
- (7) Flash test

VOLTAGE RATIO

Fig. 1 shows the connections for checking the voltage ratio, when the secondary voltage is known approximately and is within the range of an available voltmeter. The meter should preferably be of the electrostatic type or a moving-coil instrument and rectifier with a resistance of at least 1,000 ohms per volt.

If the output of the secondary is not known or is not within the range of an

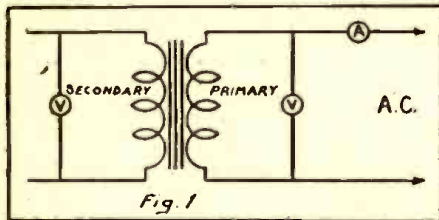

available voltmeter, it is safer to connect the A-C line across the secondary and measure the primary volts. An obvious exception is a filament transformer or a model-railway transformer, but these types of transformer can easily be identified by the fact that the secondary winding has a very low D.C. resistance, whereas the primary has a medium resistance. The comparison of resistances can be made with the aid of a battery and flash-lamp bulb. The lamp will light to about half brilliancy with the primary in series, but will light to full brilliancy when a low-voltage secondary is connected in series. This method can be used to identify the windings of a power pack transformer, as the high-voltage secondary is usually of such a high resistance that the lamp will not light at all.

TEMPERATURE RISE

Although this may not seem to be very important, the temperature rise of a transformer should be checked. The reason is that in using ordinary insulating materials it is necessary to limit the maximum temperature at any spot inside the coil to about 90° C. (190° F.), this being the maximum temperature to which normal insulation should be allowed to be heated. Except by inserting thermo-couples inside the windings, it is not easy to discover the actual "hot spot" temperature of the transformer, consequently it is usual to measure the temperature on the surface of the windings by means of a thermometer (Fig. 2).

Another method is to measure the variation in the resistance of the windings as the transformer heats up, but this is not always convenient or necessary. With a thermometer it is usual to limit the rise above room temperature to 30° C. (86° F.), so that assuming the room is at 20° C. (68° F.), this allows for an actual surface temperature of 50° C. (122° F.). This figure should never be exceeded when testing in the open

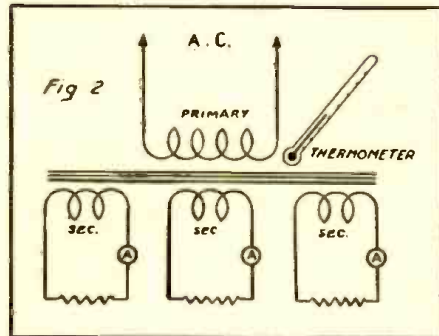

because in actual operation the transformer is usually inside a closed cabinet and the cooling will not be so effective. When conducting tests, a piece of plasticine should be used to bed the thermometer on to the windings. If the test is run for a considerable time the temperature of the core can be measured. The tests should be taken with full-load currents in all windings.

POLARITY

Sometimes it is useful to know the polarity of transformers, such as when connecting them in parallel. This may be deter-

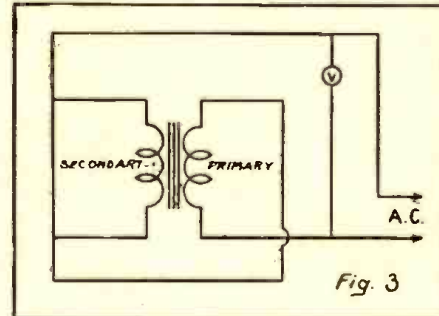

mined, if the primary and secondary are connected in series and placed across the A-C supply as shown in Fig. 3. The voltage across the secondary will be smaller than the line voltage when the windings are of the same polarity. When the polarities are reversed, the secondary voltage will be greater than the line voltage.

IRON LOSS

Fig. 4 shows the connections for an iron loss test. The voltmeter and ammeter give

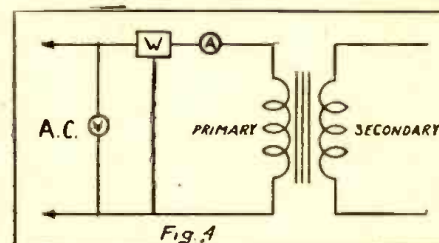

the V.A. (Volts-Amps) of the primary and the wattmeter gives the actual watts consumed. Except for unity power factor these values will not be equal and when measured give an approximation of the

Power Factor:

$$P.F. = \frac{\text{Watts}}{\text{Volts} \times \text{Amps}}$$

The power loss in the core, due to eddy-currents and hysteresis, are obtained by dividing the power, as read on the wattmeter, by the voltage across the primary.

COPPER LOSS

The copper-loss test is carried out in the same way as the iron-loss test, except that the secondary is shorted. The voltage ap-

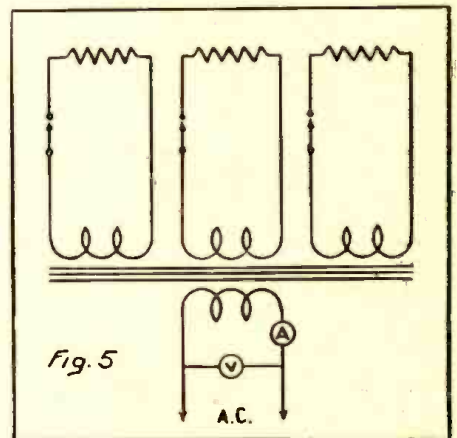

plied in this case should be very much less than the normal line voltage so that the current flowing in the secondary is limited to its normal full-load value (which can be measured with a meter in series with the winding). Alternatively, the primary voltage can be arranged to give the calculated primary current on full load.

Whereas the iron loss is practically constant for all loads (being roughly proportional to the square of the voltage), the copper loss increases with the square of the current. The copper loss is given by the wattmeter reading.

REGULATION AND EFFICIENCY

Fig. 5 shows the connections for regulation test. The secondaries are loaded up to their full value with resistances of a non-inductive type, and switches arranged so that the transformer may be tested with and without load. The voltage of the winding to be checked is measured first on no load and then on full load and the regulation percentage obtained from the expression:

$$\text{Regulation} = \frac{100 (\text{No load Volts} - \text{Full load Volts})}{\text{Full load Volts.}}$$

$$\text{The efficiency} = \frac{\text{Total secondary Watts} \times 100}{\text{primary Watts.}}$$

FLASH TEST

To check the insulation between windings and from copper to ground a flash test is necessary. For ordinary small transformers with 250 volts secondary a flash test at about 800 volts is all that is necessary.

—Radio Society of Great Britain Bulletin

EMERSON MODEL 436 HIGH-FIDELITY A.C. SUPERHETERODYNE

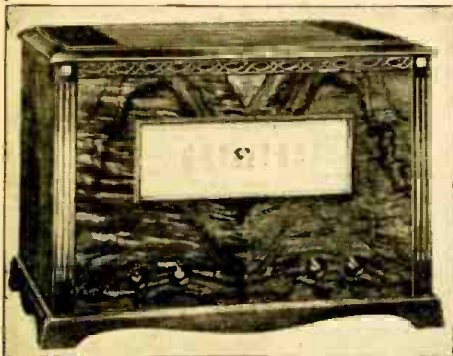

This Emerson 8-tube High-Fidelity receiver has an output rating of 20 watts.

GENERAL NOTES

The receiver should never be turned on with either the speaker plug or the 6L6G tubes out of their respective sockets, since the rapid rise in rectifier voltage will damage the electrolytic condenser.

When replacing the chassis in the cabinet take precautions to keep any part of the dial and condenser assembly from touching the cabinet, otherwise microphonism will result. The color coding of the I-F transformers is as follows:

Grid—green Plate—blue
B plus—red Grid return—black

The color coding of the power transformer is as follows:

Primary—two black leads
High-voltage secondary—two red leads
High-voltage secondary center tap—red and yellow lead
6.3 volt secondary—two green leads
5 volt secondary—two yellow leads

The switch located at the rear of the chassis is provided to allow the use of either the enclosed loop antenna or an external antenna. Push the switch to the left for use of external antenna.

The receiver has a self-contained antenna loop and normally does not require additional antenna or ground connection. However, in locations far removed from broadcast stations or, in shielded locations, an outside antenna may be used to improve reception of weak stations.

ADJUSTMENTS

An oscillator with frequencies of 455, 600 and 1600 kc should be used.

An output meter should be used across the voice coil or speaker output transformer for observing maximum response.

Use a standard dummy antenna or a .0002 mf condenser for aligning the antenna coil.

Always use as weak a test signal as possible during alignment.

The last motion in adjusting trimmers should always be a tightening one, not a loosening one.

Never leave the trimmer with the outside plate so loose that there is no tension on the screw. Either bend the plate up or remove

the screw entirely. Loose screws are a sure source of noise, drifting, and microphonism.

Location of Coils and Trimmers

The two triple-tuned I-F transformers are mounted in cans on the top of the chassis. The trimmers are available through holes in the tops of the cans. The copper colored screw is for the tertiary coil. The first I-F transformer is next to the 6L6 tube.

The broadcast antenna coil is the open coil on the top of the chassis between the 6SA7G and the 6K7GT I-F tube. The trimmer for the coil is mounted on top of the coil.

The interstage coil is the larger of the two coils underneath the chassis. Its trimmer is located on the right end section of the variable condenser.

The trimmer for the loop is mounted on the loop board.

I-F Alignment

Push the switch at the rear of the chassis to "external antenna" and feed 455 kc through a .01 mf condenser to the grid of the 6K7 I-F tube. Unscrew the copper colored screw of the second I-F transformer as far as possible and then align the other trimmers of this transformer for maximum response. Shift the input to the grid of the 6SA7 (clip input to stator lug of right end section of variable condenser) and repeat the same procedure on the first I-F transformer. Do not disturb the alignment of the second I-F transformer. Feed the signal again to the 6K7GT I-F tube, shunt the primary and secondary of the second I-F transformer with 25,000 ohm resistors, and adjust the tertiary (copper color) trimmer for maximum response. Again feed the grid of the 6SA7, shunt the primary and secondary of the first I-F transformer with resistors and then, without removing the shunting resistors from the second transformer, adjust the first transformer tertiary for maximum response. Do not disturb the alignment of any of the second I-F trimmers. Remove the resistors and sweep the signal generator through the band. The response should be quite flat with a slight peak in the middle, with a band width of about 10-12 kilocycles.

Visual alignment may be used in which case a similar procedure should be followed except that it will be unnecessary to shunt the transformers with resistors. With either method of adjustment, however, the alignment should be repeated until a satisfactory, broad response curve is obtained or the fidelity of reception will be seriously impaired.

R-F Alignment

With the switch at the rear of the chassis in the position marked "external antenna" set the pointer at 60 and feed 600 kc to the external antenna lead through a standard dummy antenna or a 0.0002 mf mica condenser. Adjust the series padder (located at the left of the variable condenser, on the top of the chassis) for maximum response. Move the pointer to 160, feed 1600 kc and align first the oscillator trimmer (right end condenser section) and then the interstage and antenna trimmers (see preceding for location) for maximum response. Return to 600 kc and adjust the series padder (while rocking the variable back and forth) for maximum re-

sponse. Realign at 1600 kc.

To align the loop, set the dial pointer at 160. Set the signal generator at 1600 kc and feed its output into a loop of wire about 12 inches in diameter. Hold this radiating loop about 12 inches from and parallel to the receiver loop antenna. Advance the output of the signal generator until deflection is obtained on the output meter and then adjust trimmer on loop for maximum response.

RECORD-CHANGER MODEL

The Emerson Model 372, housed in the Georgian period console, contains the same chassis as the high fidelity receiver but has in addition an automatic record changer. For this model the following notes apply:

Before servicing the automatic record changer, inspect the assembly to see that all levers, parts, gears, springs, etc., are in good order and are correctly assembled.

A bind or jam in the mechanism can usually be relieved by rotating the turntable in the reverse direction.

The changer can be conveniently rotated through its change cycle by pushing the index lever to "Reject" and revolving the turntable by hand. Six turntable revolutions are required for one change cycle.

If the record changer or cabinet is not perfectly level, normal operation is likely to be affected.

The 10 and 12 inch records must be absolutely flat for smooth operation when using a mixture of the two sizes.

Incorrect adjustment of a particular mechanism of the changer is generally exhibited in a specific mode of improper operation. The following relations between effects on operation and the usual misadjustments will enable ready adjustment in most cases.

For any irregularity of operation, the adjustment of the main lever should be checked first.

If needle does not land properly on 12 inch record but correct on 10 inch—Effect adjustment "E".

On failure to trip at end of record—Increase clutch friction by means of screw. Also, see that levers are free to move without touching each other.

If pickup strikes lower record of stack or drags across top record on turntable—Adjust lift cable.

If needle does not track after landing—Friction clutch adjustment may be too tight; there may be a bind in tone arm vertical bearing; levers fouled; or pickup output cable twisted.

If cycle commences before record is complete—Record is defective, or adjustment of friction clutch is too tight.

A wow in record reproduction indicates that the record is defective.

If record knives strike edge of records—Records warped; record edges are rough; or knife adjustments are incorrect.

Record not released properly—Adjust record shell assemblies in respect to shaft.

Needle lands in 10-inch position on 12-inch record or misses record when playing both types intermixed—Increase tension of pickup locating lever spring.

VOLTAGE ANALYSIS

Readings should be taken with a 1000 ohms-per-volt meter. Voltages listed below are from point indicated to ground (chassis) with the volume control turned on full and no signal. Line voltage for these readings was 117 volts, 60 cycles, a.c. All readings except B plus at rectifier, heaters, and cathode voltages were taken on 300 volt scale.

Tube	Plate	Screen	Cathode	Heaters
6K7GT	245	70	0	6.3
6SA7GT	245	70	0	6.3
6K7GT	235	70	0	6.3
6SQ7GT (det.)	125	—	0	6.3
6SQ7GT (P.I.)	150	—	0	6.3
6L6 (2)	275	285	±8.5	6.3

Voltage drop across field—65 volts.
Voltage at 5Z3 filament to ground—350 volts.

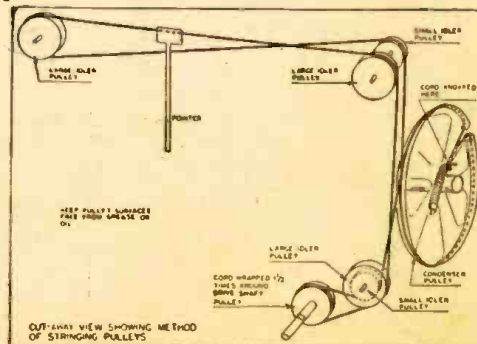

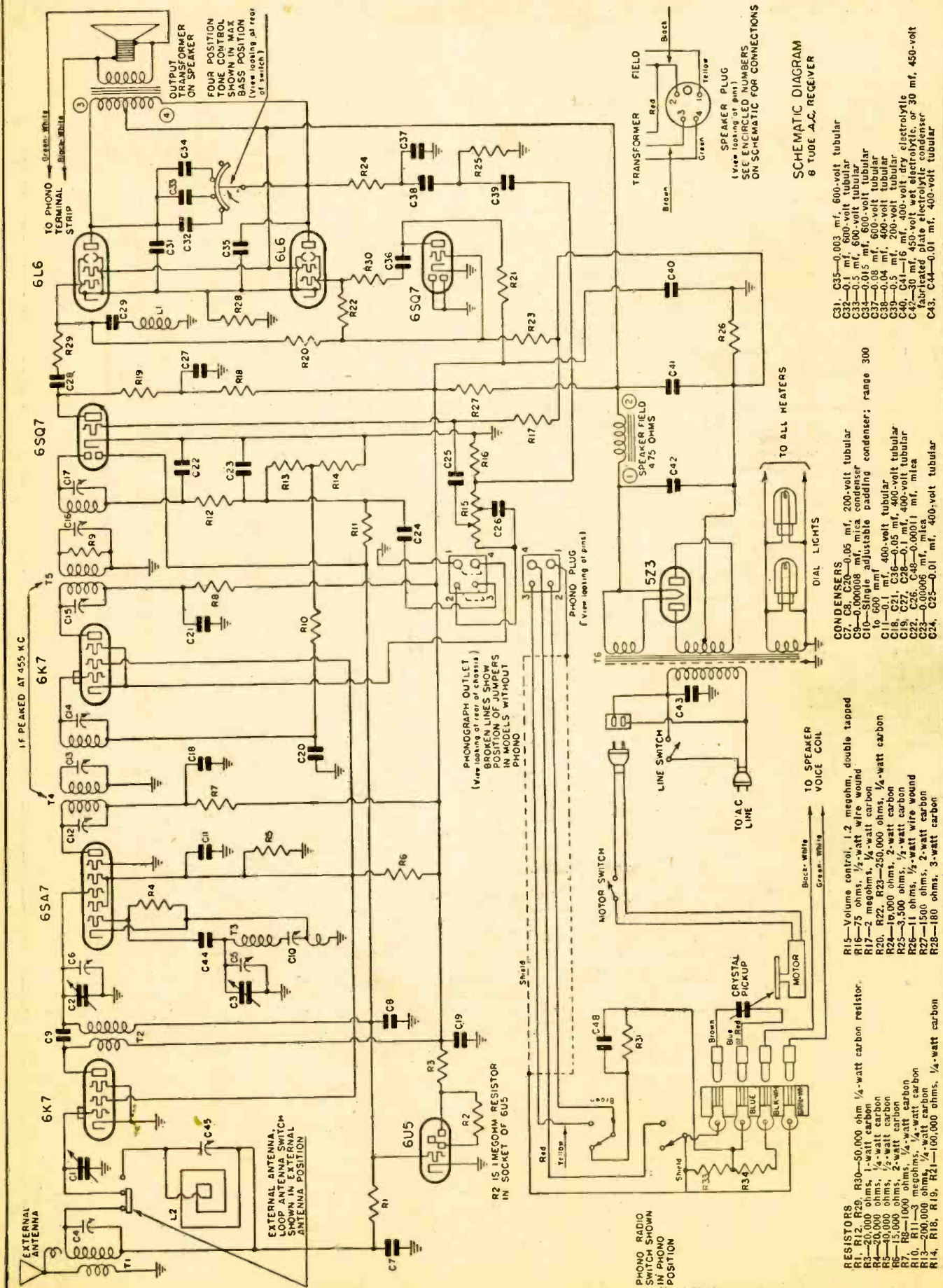

LOW-CAPACITANCE A-C POWER SUPPLIES

By GARRARD MOUNTJOY and CHARLES W. FINNIGAN*

ACCEPTABLE HUM INTENSITIES

MODULATION hum may be measured in decibels below 100 per cent modulation for full undistorted signal output. Reduction in hum to provide a 40-db discrepancy may be considered acceptable for some low-priced designs, with 50 db considered excellent and 60 db superlative. Zero signal hum levels may be measured directly in intensity. With a medium sized dynamic speaker of average sensitivity the consumer used to be satisfied with as much as 100 microwatts of hum. However, within the last few years the economy of high capacitance electrolytics has enabled the ready reduction of hum to 5 microwatts or so. This reduction is definitely too conservative and it is doubtful that the majority of consumers will discriminate between no hum and say, 20 microwatts, other commercial factors being satisfactory. While electrolytics are still available the 5 microwatt level may easily be achieved, even with reduction of capacitance below the values now being used in practice. However, if the curtailment of aluminum forces the use of paper condensers or electrolytics of comparable capacitance values then consideration should be given to higher hum output levels. In the event of a critical shortage some universal sacrifice in hum level should be made to enable the production of the largest number of sets from the available materials.

POWER FACTOR OF CAPACITORS

The power factor of electrolytics is usually higher than that of paper capacitors, but in any usual application the resistance component of either may be neglected. Hence, in the systems described electrolytics may be used in place of paper wherever capacitance drift inherent with electrolytics is not a disturbing factor.

HUM REDUCTION IN A-C RECEIVERS

In the past, with aluminum available in any desired quantity, the price of electrolytics increased very little with increase in capacitance above a certain base price. This led to the then economical filter design

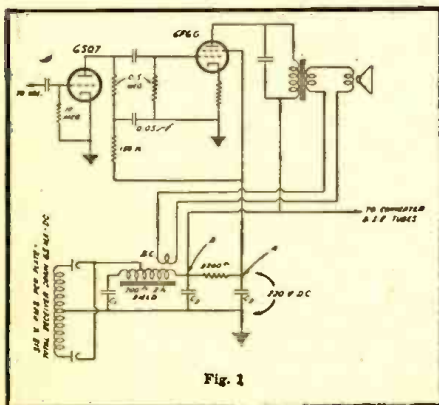

*Now with Stromberg-Carlson Telephone Manufacturing Company, Rochester, N. Y. RCA License Laboratory, New York, N. Y.

SUMMARY—With the curtailment of strategic materials, particularly aluminum, the design of power filters with a minimum of capacitance is of increasing importance.

If aluminum for electrolytics is to be available in restricted quantity, the use of low-capacitance sections, say 1/3 the size of previous liberal design practice, is indicated. If, however, aluminum is to be restricted totally, then paper capacitors are the logical substitute. This paper describes a few filter systems which employ sufficiently low-capacitance filter sections to permit the use of paper capacitors in lieu of aluminum, or of very small electrolytics if aluminum is available.

The systems described herein take into account the importance of copper and steel, and hence consider comparable systems with and without filter chokes. The systems do not require dynamic speaker fields larger than those commonly associated with small receivers.

The number of "filter circuits" conceivable is unlimited, and the systems discussed herein are merely those of the many tried in this development which permit the use of paper capacitors of moderate size and number.

Doubtless there are other systems which will produce comparable or perhaps even better results. The systems below are hence offered for comparison as well as for their own merit. Nevertheless it is believed that they require something like a minimum of capacitance where criticality is a factor.

wherein two large electrolytics were used in conjunction with a speaker field or filter resistor. Economy in microfarads of capacitance, however, is indicated by the use of several sections of lower capacitance. For example, three 3- μ f sections of capacitance may produce a lower hum level in the speaker than two 12- μ f sections, with a marked reduction in aluminum. Very probably the future technique of filter design will be directed toward the reduction of materials and away from the reduction of filter sections. Labor costs may be increased by this trend, yet indications are that labor will be more available than material.

One of the most simple and economical expedients for the reduction of hum is to employ cathode degeneration in a single-tube power output stage. This produces an improvement in zero signal hum of some 6 db, reducing hum derived from plate, screen, and driver tube, and minimizing the effect of inaccuracy in speaker bucking-coil balance. Its use also conserves the capacitor usually used as a cathode bypass. The loss in audio gain may be tolerated in most designs.

Since the power-tube screen circuit is more susceptible to hum than the plate circuit a separate screen filter usually proves more economical of material than the use of a common voltage point for screen and plate.

A system which follows this plan is shown in Figure 1. A tapped field to minimize hum at point B is indicated. The hum voltage at B is 3.5 r-m-s volts and at

A is 1.6 volts. This produced 17 microwatts of hum in the voice coil of substantially 120-cycle tone. The speaker used was of the light six-inch type having a 700-ohm 2-henry field utilizing 0.2 pound of copper in the winding. The capacitors used were:

- $C_1 = 1 \mu\text{f}$
- $C_2 = 2 \mu\text{f}$
- $C_3 = 1 \mu\text{f}$

Increasing C_3 to 2 μ f reduced the zero signal hum to 5 microwatts. The capacitors used were paper. If electrolytics were used the sections could be of comparable values with C_1 increased to say 3 μ f and the tap omitted from the field. This would permit wider capacitance drift. This type of balance is not very critical, however, permitting C_1 to vary from 0.5 to 2 μ f without important change in hum level.

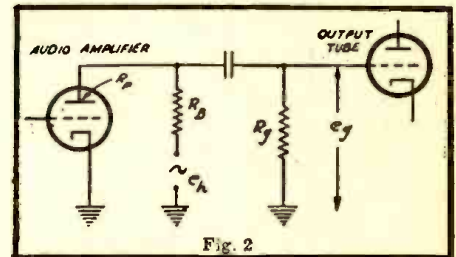

The balance between voice coil and bucking coil was found satisfactory, limiting the induced hum power from field to voice coil to a negligible level. The necessity for exact balance increases somewhat with the magnitude of ripple volts across the field and imposes this precaution in manufacture. Filter systems using large electrolytic input or choke input will permit wider variation in bucking-coil balance as the hum intensity in the field is much less. In the case shown in Figure 1 the ripple voltage was 80 r-m-s volts.

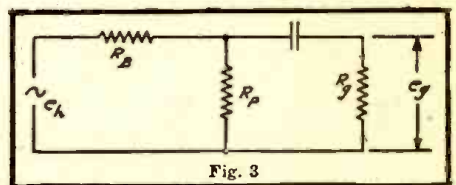

Power-supply ripple may appear on the grid of the output tube through the plate circuit of the driver as shown by Figure 2. The portion of the ripple which is impressed on the grid is determined by the voltage divider formed by R_b , R_p , and R_r of Figure 3. R_p increases somewhat as the value of R_b is increased as shown in Figure 4. The rate of increase of R_p is not commensurate with that of R_b , however, so that the greatest reduction of hum is obtained by making R_b as large as possible. The limiting value of R_b will then be determined by the size of R_r which may be increased up to the limit imposed by gas

current conditions in the power-tube grid circuit. From this standpoint self bias operation of the power tube is to be preferred to fixed bias since a much higher value of R_g is then permissible. The hum may be still further reduced, if necessary, by a resistance capacitance filter in series with R_b . The filter may be of high resistance, low capacitance, if R_b is also high, with a resulting economy. A section comprising

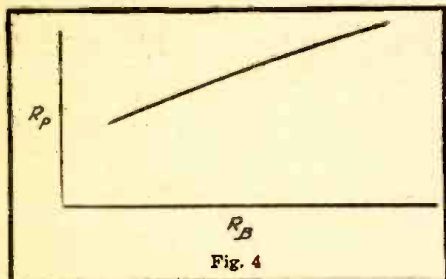

a 150,000-ohm resistor and a 0.05- μ f capacitor is indicated in Figure 1. This prevented any contribution to hum from the driver tube.

The use of a filter choke will permit the deletion of a filter section, as shown in Figure 5. Only if the choke is tuned may the inductance be small. The type used

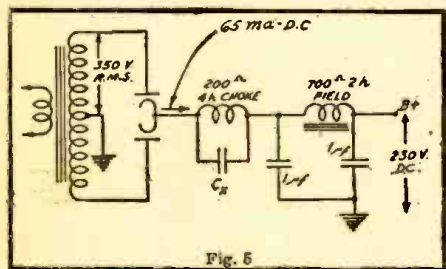

was 4-henry, 200-ohm, using 0.085 pound of copper and 0.42 pound of steel.

The speaker of Figure 1 was used without the tap as the use of the tap in this case introduced too many harmonics.

The choke was of little value until it was tuned. The tuning is not critical, and most acceptable hum output, tone considered, was obtained when the tuning capacitor C_x was made small, say 80 per cent of its resonating value. The resulting harmonic content of the hum was then greatly reduced. The use of the choke filter requires in addition to the choke and tuning capacitor an increase in secondary

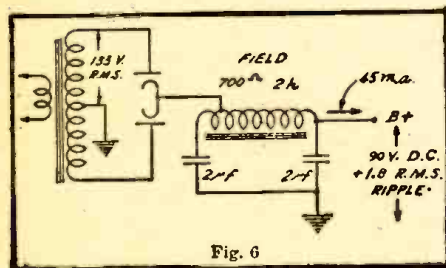

voltage on the power transformer with resulting increase in copper. The ultimate desirability of choke input may be determined by considering the availability and costs of copper and steel vs. the materials for paper or electrolytic capacitors.

Acceptable modulation hum requires a low-ripple voltage on the screens of the carrier and I-F frequency tubes, in the

order of 0.3 volts. In the "straight A.C." type of set an appreciable drop in D.C. voltage from $B+$ to screen is required. The dropping resistor serves as one leg of a filter which may be terminated by a capacitance from these screens to ground. A capacitor in the order of 0.5 μ f is adequate. The A.C.-D.C. type circuits do not lend themselves readily to filtering with low capacitance values, since high storage capacity of the first capacitor is required to maintain a good D.C. output.

This may be illustrated by the following measurements which were obtained using an A.C.-D.C. receiver having a current drain of 45 milliamperes. Using an A.C. line voltage of 120 volts the following relation was established between the filter input capacitance and the rectified voltage developed:

Capacitance	D.C. Voltage
20 μ f	116 Volts
10 "	107 "
8 "	103 "
6 "	98 "

Less than 12- μ f sections will cause objectionable hum. It would seem therefore that A.C.-D.C. operation is dependent upon electrolytics for its utility, with something like two 20- μ f sections working in conjunction with a speaker field as the probably desirable minimum. Tapped field circuits and other balancing systems may reduce this estimate considerably although balancing systems are only effective when the balance is not critical and when the hum level resulting from unbalance is not intolerable.

If the A.C.-D.C. size of chassis is still desirable in the event electrolytics are not available the voltage-doubler system may

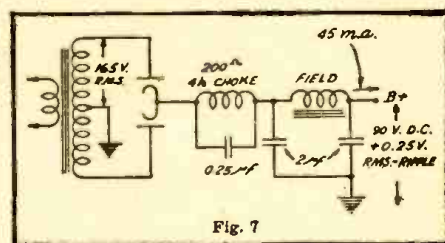

have merit, as these systems may be built with less total capacitance than the A.C.-D.C. type for the same D.C. voltage output. The following D.C. voltages were measured at the filter input of a voltage-doubler system operating from a 120-volt line with a current drain of 55 milliamperes. The filter input was composed in each case of two condensers of the capacitance indicated, connected in series.

Capacitance	D.C. Voltage
8 μ f	224 Volts
4 "	163 "
2 "	136 "

Also the voltage-doubler system has as its fundamental frequency 120 cycles instead of the more difficultly filtered 60.

The 120-cycle pulse may also be produced by a low-voltage transformer and full-wave rectification. Unfortunately the screens of the converter R-F and I-F tubes are not easily filtered by RC networks unless an appreciable D.C. voltage differential is produced. The circuit and constants of Figure 6 produced low zero-signal hum, but had considerable modulation hum. The choke input method illustrated in Figure 7 is capable of further reduction in zero-signal hum with considerable reduction in

(Continued on page 55)

Operating Notes

Trouble in . . .

MOTOROLA AUTO RADIOS 1940-41-42 MODELS

These sets may have a great deal of background hiss at high volume setting and little or no signal. Customer usually objects to this, especially in remote from station areas. Here is a good remedy: Cut R.F. and I.F. tube cathodes from ground. To R.F. cathode, connect 20,000 ohm 1/2-watt resistor and .05 600-volt condenser, ground other end of each resistor and condenser. To I. F. cathode connect 500 to 5,000 ohm 1/2 watt resistor (resistance according to set model and amount of suppression required in your particular locality). Ground this resistor and by pass with .01 600-volt condenser. A slight loss of sensitivity will result, but background noise will be reduced 75% or better, actually resulting in better daytime reception.

FORD-MERCURY AUTO RADIO 1940-41-42

To repair antenna connector plug on top of chassis damaged by backing car out of low garage door with antenna extended. This gives antenna a violent snap usually breaking the little fibre wafers that hold antenna plug in place. Repair: After removing set from car and removing side plates, work a stiff wire, with small hook on end, through plug sleeve from top, hook on sleeve and pull up into place, lining it up in center of casting so antenna end will properly engage it. Then bend wire over a nail or small stick so it holds sleeve tightly. Then fill casting around sleeve with good cement (I use Duco Household cement) and let harden 24 to 48 hours. I have found it best to leave broken fibre wafers in place if at all possible as cement works between them and forms a solid contact. This is generally stronger than the original connection. The plastic nut that tightens antenna to set is also usually broken, and I put the pieces together and wrap them with 2 or 3 turns of ordinary surgical gauze soaked with Le Page's glue. When this dries I trim out top hole with a knife and smooth up with fine sandpaper. Keep glue out of threads on inside of nut. I have found the above repair satisfactory in every way and they come in handy, as replacement of the damaged parts are difficult and parts are not readily obtainable.

On small Pushbutton sets with mechanical P. B. Tuning, the dial scale is usually fastened permanently in the cabinet. Before removing chassis, I set a button on each of the alignment frequencies: 1500 kc.; 600 kc.; and 1200 kc. The latter is only necessary to push the right button to get each exact dial setting.

To help locate noisy resistors, I have a short length of rubber-covered wire with ends skinned and momentarily short out suspected resistors. Usually does not upset a circuit that a noisy resistor, generally in screen or cathode circuit, will not show up. Caution: keep off filament or coil shunting resistors. However, these are seldom at fault.

B. F. ADAMS,
Fortuna, Calif.

SILVERTONE MODEL 2541

Complaint: Battery fails sooner than it should; on checking the battery I find that it is dead. Trouble: Shorted 10-mf. 100-volt condenser connected between the ground on chassis and the $B+$ on the plates and screens of the 1N5, 1A7 and 1A5. Replace with 10 mf. condenser having a higher working voltage. In some cases it can be left out entirely.

JOHN W. BURGER,
Westphalia, Kansas

RECEIVING-TUBE CHARTS

The radio serviceman as well as the radio experimenter will find a considerable amount of useful information in the new RCA Receiving Tube booklet, just off the press, the tube-classification charts of which are reproduced here.

The receiving tube characteristic charts in the booklet contain 327 types arranged in numerical-alphabetical sequence. The tube listings take into account replacements for types discontinued by the War Production Board order on manufacture of re-

ceiving tubes for other than war use. The chart showing tubes discontinued and RCA direct and possible replacements appeared in *Radio-Craft* for July on page 657. It will be noted from the classification chart shown here that the GTs and Gs are now represented by a single tube designated as GT/G.

The booklet contains another chart on special purpose tubes giving information on certain tubes closely allied to receiving tubes but customarily tabulated separately

and identified by the term "special purpose." These tubes are particularly of interest for applications involving special performance requirements.

The beginner in servicing and the newcomer in radio experimenting should find the reproduced classification charts instructive because of the groupings of tubes into classes of specific functions and the listings of filament voltages in which these tubes are available. Obsolete types of tubes are not listed in the charts.

Cathode Volts		1.4	2.0	2.5 to 5.0	6.3	12.6 to 117
DIODE DETECTORS & RECTIFIERS						
Detectors	single twin	1A3			(6H6, 6H6-GT/G), 7A6	12H6
	half-wave				1-v	12Z3, 35Z3, 35Z4-GT, 35Z5-GT/G, 45Z3, 45Z5-GT
	half-wave, with beam power amplifier					32L7-GT, 70L7-GT, 117L/M7-GT, 117N7-GT, 117P7-GT
Rectifiers	half-wave, with power pentode					12A7, 25A7-GT/G
	full-wave	vacuum		(5T4, 5U4-G, 5X4-G, 5Z3), (5W4, 5W4-GT/G, 5Y3-GT/G, 5Z4, 5Y4-G, 80), (5V4-G, 83-v)	(6X5, 6X5-GT/G, 84), 6Y5, 6Z5, 6ZY5-G, 7Y4	
		mercury gas			82, 83	
Rectifier-Doublers		Cold-Cathode Types: 0Z4, 0Z4-G.				(25Z6, 25Z6-GT/G, 25Z5, 25Y5), 50Y6-GT/G, 50Z7-G, 117Z6-GT/G
DIODE DETECTORS with AMPLIFIERS						
One Diode	with high-mu triode	(1H5-G, 1H5-GT), 1LH4				
	with high-mu triode, r-f pentode	3A8-GT*				
	with medium-mu triode, power pentode	1D8-GT				
	with pentode	1S5				
	with power pentode	1N6-G				
Two Diodes	with medium mu-triode		(1B5, 1H6-G)	55	(6SR7, 6R7, 6R7-G, 6R7-GT, 6ST7, 6V7-G, 85), 6C7, 7E6	12SR7
	with high-mu triode			2A6	(6SQ7, 6SQ7-GT/G, 6Q7, 6Q7-G, 6Q7-GT, 6B6-G, 6T7-G, 75), 7B6, 7C6	(12SQ7, 12SQ7-GT/G, 12Q7-GT)
	with pentode		(1F7-G, 1F6)	2B7	(6B8, 6B8-G, 6B7, 6B7-S), 6SF7, 7E7	12C8, 12SF7
CONVERTERS & MIXERS						
Pentagrid Converters		(1A7-G, 1A7-GT), 1R5, 1B7-GT, 1LA6	(1C7-G, 1C6), (1D7-G, 1A6)	2A7	(6SA7, 6SA7-GT/G, 6A8, 6A8-G, 6A8-GT, 6D8-G, 6A7, 6A7S), 7B8, 7Q7	(12SA7, 12SA7-GT/G, 12A8-GT)
Triode-Hexode Converters					(6K8, 6K8-G, 6K8-GT),	12K8
Triode-Heptode Converters					6J8-G, 7J7	
Octode Converters					7A8	
Pentagrid Mixers					(6L7, 6L7-G)	

		Cathode Volts	1.4	2.0	2.5 to 5.0	6.3	12.6 to 117
VOLTAGE AMPLIFIERS, DETECTORS, OSCILLATORS							
Triodes	medium-mu	single unit	1G4-GT/G	(1H4-G, 30)	27, 56, 485	(6C5, 6C5-GT/G), (6J5, 6J5-GT/G, 7A4), (6P5-GT/G, 76), 6L5-G, 6AE5-GT/G, 37	12J5-GT
		twin unit	3A5*			6C8-G, 6F8-G, 6J6, 6SN7-GT	12AH7-GT 12SN7-GT
		twin plate				6AE6-G	
		twin input				6AE7-GT	
		with power pentode				6AD7-G	
	high-mu	with diode, power pentode	1D8-GT				
		single unit				6SF5, 6SF5-GT, 6F5, 6F5-G, 6F5-GT), 6K5-G, 7B4	(12SF5, 12SF5-GT, 12F5-GT)
		twin unit				(6SC7, 7F7), 6SL7-GT	12SC7 12SL7-GT
	Tetrodes	with diode, r-f pentode	3A8-GT*				
		remote cut-off			1D5-GT	35	
Pentodes	sharp cut-off			32	24-A	36	
	remote cut-off	1T4, 1P5-GT	(1D5-GP, 1A4-P), 34	58	6SS7, (6SK7, 6SK7-GT/G, 6K7, 6K7-G, 6K7-GT, 78), (6S7, 6S7-G), (6U7-G, 6D6, 6E7), 6W7-G, 39/44, 7A7, 6AB7, 6AC7, 7H7, 7B7	(12SK7, 12SK7-GT, 12K7-GT), 14A7/12B7	
	remote cut-off, with triode				6F7, 6P7-G	12B8-GT, 25B8-GT	
	semi-remote cut-off				6SG7	12SG7	
	sharp cut-off	(1N5-G, 1N5-GT), 1L4, 1LN5	(1E5-GP, 1B4-P), 15	57	6AG5, 6SH7, (6SJ7, 6SJ7-GT, 6J7, 6J7-G, 6J7-GT, 6D7); 77, 6C6, 7C7, 7G7/1232	12SH7, (12SJ7, 12SJ7-GT, 12J7-GT)	
	sharp cut-off, with diode, high-mu triode	3A8-GT*					
POWER AMPLIFIERS							
Triodes	low-mu	single unit		31	2A3, 45, 183/483	6A3, 6B4-G	
		twin unit				6E6	
	high-mu	single unit		49	46	6AC5-GT/G, 6C4	25AC5-GT/G
		twin unit	1G6-GT/G	(1J6-G, 19)	53	(6N7, 6N7-GT/G, 6A6), (6Y7-G, 79), 6Z7-G	
Beam Tubes	without rectifier	(1Q5-GT/G, 3Q5-GT/G*), 1T5-GT			(6L6, 6L6-G), (6V6, 6V6-GT/G), 6Y6-G, 7A5, 7C5	(25L6, 25L6-GT/G), 25C6-G, 35A5, 35L6-GT/G, 50L6-GT	
	with rectifier					32L7-GT, 70L7-GT, 117L/M7-GT, 117N7-GT, 117P7-GT	
Pentodes	single unit	1A5-GT/G, (1S4, 3S4*), 1C5-GT/G, 1LA4, 1LB4, (3A4*, 3Q4*)	(1F5-G, 1F4), (1G5-G, 1J5-G), 33	2A5, 47, 59	(6F6, 6F6-G, 42), (6K6-GT/G, 41), 6C6-G, 38, 6A4, 89, 7B5	12A5, (25A6, 25A6-GT/G, 43), 25B6-G	
	twin unit		1E7-G★				
	with diode & triode	1D8-GT					
	with medium-mu triode				6AD7-G		
	with rectifier					12A7, 25A7-GT/G	
Direct-Coupled Amplifiers					6AG7, 6B5, 6N6-G	(25B5, 25N6-G)	
ELECTRON-RAY TUBES							
Single	with remote cut-off triode					6AB5/6N5, 6U5/6G5	
	with sharp cut-off triode				2E5	6E5	
Twin, without triode						6AD6-G, 6AF6 G	
GAS-TRIODES					2A4-G		

★ Two 1F5-G's in one bulb.

* Filament arranged for either 1.4 volt or 2.8-volt operation.

NOTE: The above classification does not include the following old types: 00-A, 01-A, 10, 11, 12, 20, 22, 26, 40, 48, 50, 71-A, 81, 99, 112-A, 876, and 886.

Making a Voltmeter Read Watts

By WILLIAM G. LOFSTROM

THERE probably are many radio service shops that do not have a wattmeter. This is because many servicemen do not think that such a unit is essential to the radio shop. Others believe that a wattmeter is too expensive a piece of test equipment for them to own. But they are wrong on both counts. You need not worry about the expense, if you desire a wattmeter. It need not be the expensive dynamometer-type meter. You can construct your own wattmeter right in your own shop in your spare time, using odd parts which now are lying around your shop accumulating dust. When you will have constructed this wattmeter and put it into operation you will wonder how and why you ever got along without one.

All that you need to construct this wattmeter is an old power transformer which still possesses a good 110-volt primary winding, a low-range A-C voltmeter, a female receptacle and some wire.

All of us have at one time or another had a set on our bench that started smoking soon after it was switched on. If you had a wattmeter in your shop on this occasion and had checked this set first for wattage consumption, you would not have had to wait for the set to start smoking. The wattmeter would have registered excess power consumption when the set was turned on. Once you have added a wattmeter to your shop, you should train yourself to use this instrument first on every set that comes into



the shop. It will save time in your service work.

Nearly all radio schematics specify the normal wattage consumption of the set being serviced, and by comparing the wattmeter reading with the specified wattage the following conclusions can be drawn.

1. If the reading obtained on the wattmeter is lower than that specified by the manufacturer, the set is drawing less than its normal current, and you can be certain that somewhere within the set there is an open circuit or circuits.
2. If, on the other hand, the reading obtained on the wattmeter is higher than that specified by the manufacturer, the

set is drawing abnormal current and you can be sure that somewhere within the set a short exists. The power supply is to be suspected first.

Although the wattmeter to be described can be mounted on the shop test panel as a permanent fixture in the shop, I decided to build this one in a metal cabinet, making it a portable unit. This enabled me to bring it into the customer's home when needed. Do you wonder why I would want to bring a wattmeter in the home of a customer? On several occasions I have had customers inquire if I could tell them how much electricity their radio set was using. Of course, I could have looked it up in the manual, but there is nothing more convincing to a customer than to let him see the answer with his own eyes. With a portable wattmeter you can do that, and even though the trip to the customer's home does not net you any cash, it will help to build up the customer's faith in you.

The metal case that I selected to house this wattmeter is a 6 x 6 x 6-inch black crackle-finish cabinet, which can be purchased from any radio supply house. The handle on the top of the cabinet can be purchased in any five- and ten-cent store. The meter that I used on this particular unit was a 0-4 A-C voltmeter, but any other low-range A-C voltmeter will do. A piece of plain paper, white in color, is pasted over the old dial scale for the new scale to be calibrated in watts. The meter hole in the upper center of the front panel will have to be cut to fit the meter which you plan to use. The hole in the lower left hand corner of the front panel is a 1/2 inch hole into which is placed a rubber grommet. The A.C. lead wire feeds through this rubber grommet. The hole in the lower right-hand corner of the front panel is cut to hold a female receptacle.

Select an old power transformer that still has a good 110-volt primary winding. Remove all the laminations and take off all the secondary windings, leaving only the primary winding, which is usually found on the bottom. Wrap a piece of Empire cloth or Kraft paper over this winding to serve as insulation. A new winding is wound over this insulation, but before proceeding it will be necessary for you to decide whether the wattmeter you are to construct will be for 125, 250 or 500 watts full-scale reading. The number of turns and the size of wire depend on the range you desire to cover. Following are the three sizes of wattmeters together with the number of turns required and the size of wire to be used:

125 watts full scale—36 turns—16 DCC wire
250 watts full scale—16 turns—16 DCC wire
500 watts full scale—8 turns—14 DCC wire

Select the size of wattmeter best suited to your needs and, using the correct wire size, wind the proper amount of turns over the insulation which now covers the old 110-volt primary winding. When this winding is completed wrap a piece of Kraft paper over it and fasten it with medical tape. The laminations are now placed into position and clamped tightly together. This completes the transformer. (For details on transformer rewinding see Fred Shuman's article in Aug.-Sept. issue of *Radio-Craft*, page 726. (Continued on page 54)

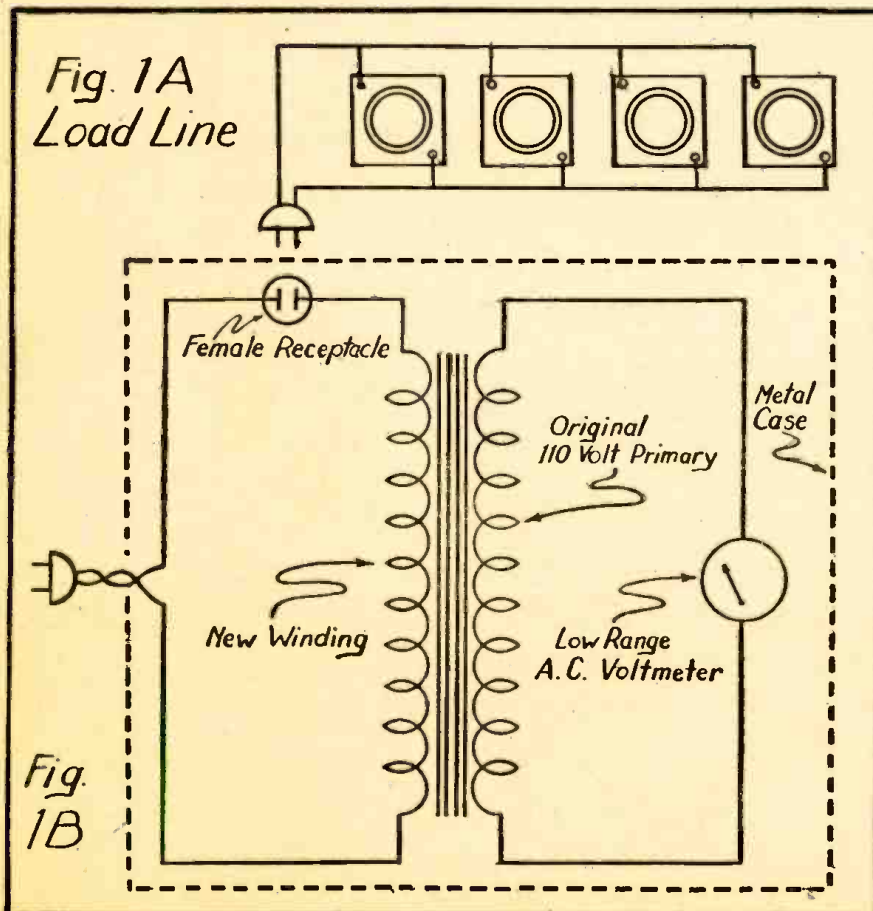

B- AND C-BATTERY ELIMINATOR FOR SERVICE TEST BENCH

By RUSSELL E. POWERS

DURING my spare time I constructed a B- and C-battery eliminator mostly from discarded parts that each serviceman has in his junk box. I believe that servicemen who have occasion to service many battery radios will find it quite useful and economical, due to the fact that it eliminates the necessity for keeping B and C batteries around the shop to use while servicing sets. The unit should cost no more than one set of B batteries. It has been suitable for every battery radio I have had occasion to service, as it supplies voltages comparable to those of the batteries used to operate the radio.

The unit first was built without a transformer, using a 117Z6GT as a half-wave rectifier, since it was intended primarily for use in servicing 1.4-volt radios. It would also work for 2-volt radios which required no C batteries and did not have the B batteries tapped for screen voltage. I found, however, that more complete isolation from the line was necessary than the AC-DC arrangement gave. With some radios it was impossible to eliminate hum even though all test equipment was A-C operated. Also, shocks were plentiful between it and almost any other metal object one might touch. In view of these objections it is recommended that anyone who contemplates building any such instrument should consider using a transformer and a full-wave rectifier.

Since layout of parts may suit one's taste, none is given here. Possibly an explanation of some of the parts, construction, and operation would prove helpful, however. A filament-type rectifier tube such as the 80, 5W4, etc., will eliminate the nuisance of having to wait for a rectifier cathode to reach operating temperature.

The unconventional hook-up of the resistor in series with the 8-mf filter condenser from the adjustable B+ to B- is not a mistake. Battery radios use a condenser from B+ to ground to keep R.F. out of the power supply. If this condenser in a radio is open, and a good condenser which has low impedance to R.F. is used in the power supply, the set will operate perfectly from the eliminator and not from batteries.

An ideal condenser to use in this place is one in which the R.F. resistance has increased due to age. If no such condenser is available one may be constructed by placing a resistance of 200 to 400 ohms in series with a good condenser. The exact value desired may be determined by disconnecting the by-pass condenser from B+ to ground in a battery radio which is in good operating condition, then experimenting with different values of resistors. A resistance should be selected so that when the

condenser in the set is disconnected the set oscillates. If too high a resistance is used the set will have poor tone quality.

The tap on the bleeder resistor, R₁, for the adjustable B+ should be adjusted so that an output of 15 ma. may be obtained at about 125 volts. The voltage with no load at this tap will be between 165 and 170 volts. The tap for screen voltage should be set so that it delivers 67½ volts under normal load. Even though some sets use 135 volts of B with a tap of 90, while others are tapped at 45, it will be found that 67½ is satisfactory. Voltage output is obtained through six pin jacks on the front panel.

A jack is provided for the full voltage output. This may be substituted for the B supply in A-C receivers and is otherwise handy to have around the shop. Sockets may be salvaged from dead A-B and B-C packs so that the radio may be plugged in with the regular battery plug. If marked wires are attached to these sockets, connections may be made with a minimum of trouble. I use a 2-volt storage battery with a 10-ohm rheostat in series adjusted to 1.4 volts for my filament supply to 1.4-volt battery radios.

The hum level of radios operated from the eliminator will be found to be low. Resistances have been selected so that one-third of the C voltage appears at the C tap. This proportion is the one most widely used; for example, the sets using a total of 9 volts of C with a tap at 3. It will be found

that other sets using a tapped C supply will work satisfactorily with the eliminator even though the proportion of total C voltage to the tap is not exactly 3 to 1. With an average-sized power transformer and resistances as indicated on the diagram, the total C voltage may be varied from zero to about 21 volts. It is necessary to have this range, as some battery radios use 22.5 volts of C.

The most desirable feature of the eliminator I have saved until last. Probably there is no serviceman who has done an appreciable amount of work on battery radios who has not at some time accidentally shorted the B batteries across the tube filaments. This usually has a detrimental effect on tube life, especially if the tube filaments are 1.4 volts and the B supply is 90. With this eliminator tube burnouts cannot happen from this cause, because the eliminator will not deliver sufficient current to do the job. The total filament drain of a 1.4-volt set with four 50 ma. tubes is 200 ma. The current which can be delivered by the adjustable B+ voltage tap does not even approach this figure. The voltage under load at the adjustable B+ tap may be varied from 90 volts on up to about 125 volts provided current requirements do not exceed 15 to 18 ma by adjusting R₁. The minimum current at which the voltage output can be held to 90 volts is 7 ma. Battery radios don't happen along which draw less than this.

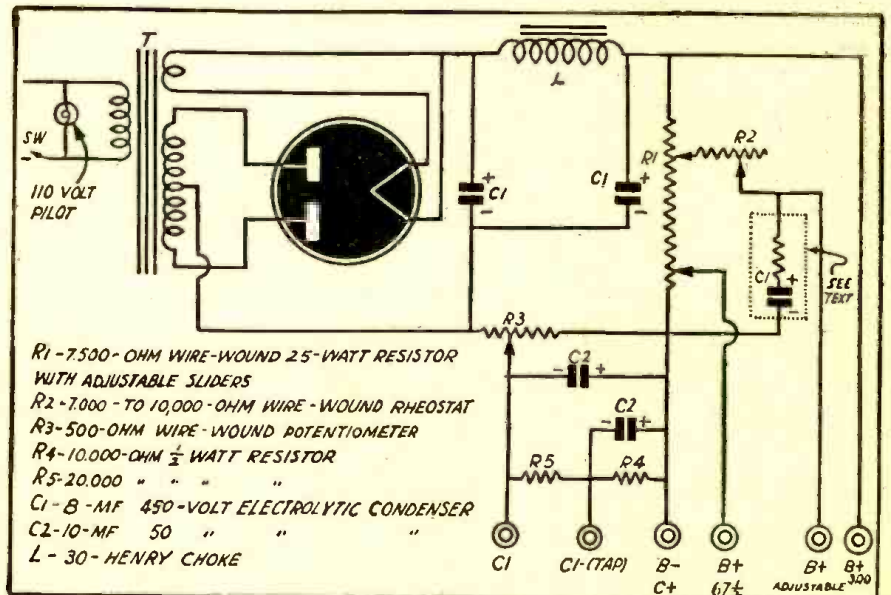

CRITICAL OCCUPATIONS LISTED FOR COMMUNICATIONS INDUSTRIES

MAKING no recommendations of its own, the Board of War Communications announced last month that lists of critical occupations in the communications industries have been forwarded to the War Manpower Commission, the Selective Service System and the United States Employment Service for such use as these agencies may find.

Separate lists for each of the different types of communications show 23 classes of critical occupations for cable companies, 45

classes for telegraph firms, 51 classes for telephone organizations, 48 classes in the various sub-divisions of commercial radio communications services, 15 classes in international short-wave broadcasting and in standard broadcasting there are 6 classes of technical workers and 3 classes of skilled personnel in program departments.

The agencies were told "The Board does not feel that it is in a position to consolidate these lists for the entire communications industry due to the fact that the nomenclature of positions and the principles applied in the inclusion or exclusion of positions have been different in the various branches of the industry."

It was suggested that the industry and labor representatives on the Board's Joint Labor-Industry Subcommittee should consult directly with the Government agencies in supplying detailed information on the functions performed by persons in the listed positions.

TRANSFORMERLESS POWER SUPPLIES

By THE ENGINEERING DEPARTMENT, Aerovox Corporation

PART I

TRANSFORMERLESS power-supply units are not new in principle. The so-called "line rectifier" and voltage doubler first attracted somewhat widespread attention among radio set builders in 1933 when the 25Z5, first of the high-voltage heater-cathode dual rectifiers, appeared. The gradual increase in distribution and application of the several types of transformerless power supplies has been concurrent with growth of the midget A.C.-D.C. radio receiver.

Aside from the well-known radio application, transformerless power supplies are applicable to test instruments and other electrical apparatus in which space is limited or magnetic fields, such as might arise from transformers, undesirable. New attention is centered upon this type of power unit at this writing because the war emergency has made it increasingly difficult to obtain certain transformers.

All of the high-voltage-heater tubes designed expressly for use in transformerless power supplies are of small size. The same is true of modern high-capacitance electrolytic filter capacitors. For certain applications, the transformerless unit is desirable over other types for inclusion in a small space with other apparatus.

Transformerless units can deliver D.C. power at high voltages or at the line voltage. The voltage multiplier circuits, while providing the potential step-up, do not possess the voltage regulation provided by transformer circuits. However, the current output and regulation may be improved by methods which will be discussed later in the text. One of the leading virtues of the simple transformerless circuit—the line rectifier—is its ability to operate from either an A.C. or D.C. line.

The usefulness of the transformerless rectifier circuit in certain applications has been slowly recognized. An understanding of the operation of the transformerless voltage multiplier circuits is not possessed by sufficient radio men who are called upon to work with this equipment.

This article will describe the various transformerless power supply circuits which have been adapted to radio receivers, electrical test instruments, photoelectric and electronic equipment, and small radio transmitters. Sufficient information will be given to impart to the reader an understanding of the circuit operation and to enable him

to set up any one of these circuits with the best components for desired operation.

HALF-WAVE CIRCUIT

The simplest transformerless power supply is the half-wave line rectifier shown in Figure 1. This is the so-called A.C.-D.C. power unit. The general design and operating principles of half-wave rectifiers apply in full to this circuit.

Operation of the circuit is well understood. The diode-type tube, *V*, conducts only on positive half-cycles of line voltage, and during those intervals the filter capaci-

tor, *C*, is charged to a voltage equal to the peak line voltage less the small drop through the tube.

On negative half-cycles, the plate of the tube is negative with respect to its cathode and it cannot conduct further. The capacitor cannot discharge back through the tube and into the line, so it discharges through the load resistance, *R*.

For the usual values of filter capacitance and load resistance, the capacitor will not get rid of its entire charge before the tube plate again becomes positive and charging current again flows. Consequently, it is seen that the charging current on each succeeding positive half-cycle will find the capacitor still partially charged, and no charging current will flow into the capacitor until the instantaneous line voltage is sufficient to exceed the voltage across the capacitor. The tube passes current flowing into both the input filter capacitor and the resistor. Total current through the rectifier is the sum of the charging current flowing into the capacitor and the load-circuit current. For a given tube, this total must not exceed a certain value stated by the tube manufacturer. The tube table included in this article shows the peak plate current which may safely be handled by the various tubes designed for transformerless power supplies.

From a study of the capacitor and resistor current magnitudes, it may be seen that the average D.C. load current is always only a fraction of the peak plate current flowing through the rectifier. If the filter capacitance permits a rectifier current higher than the manufacturer's rated peak value to flow through a tube, small safety resistors must be installed in each plate lead to limit the total current to a safe value. The value of these tube-protecting resistors may be obtained from the manufacturer's data. However they are generally of the order of 30 to 50 ohms and do not introduce too great a voltage drop in the circuit.

Since the half-wave line rectifier utilizes only alternate half-cycles of line voltage, the ripple frequency present in the rectifier output will be identical with the low line frequency. This means that the half-wave transformerless circuit is not as easily filtered as full-wave rectifiers. The supply frequency, input filter capacitance, and load resistance determine the ripple voltage and ripple current magnitudes.

Choke input is rarely ever used with the half-wave transformerless power supply; capacitor input has been found to be superior in this circuit. The half-wave unit gives best results when high-capacitance capacitors are used. The 40-mfd. electrolytic capacitor has been designed principally for this application. A large input capacitance is necessary to maintain the output voltage at a reasonable level. High-resistance filter chokes are not recommended for use in the half-wave circuit, since the output voltage is already low—somewhat less than the effective value of the line voltage—and in most cases cannot be drastically reduced.

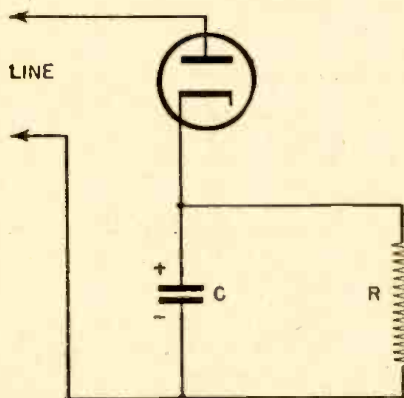

HALF-WAVE RECTIFIER
FIG. 1

tor, *C*, is charged to a voltage equal to the peak line voltage less the small drop through the tube. On negative half-cycles, the plate of the tube is negative with respect to its cathode and it cannot conduct further. The capacitor cannot discharge back through the tube and into the line, so it discharges through the load resistance, *R*.

For the usual values of filter capacitance and load resistance, the capacitor will not get rid of its entire charge before the tube plate again becomes positive and charging current again flows. Consequently, it is seen that the charging current on each succeeding positive half-cycle will find the capacitor still partially charged, and no charging current will flow into the capacitor until the instantaneous line voltage is sufficient

VOLTAGE DOUBLER CIRCUITS

The transformerless voltage multiplier

CHARACTERISTICS OF TRANSFORMERLESS POWER-SUPPLY TUBES

Type	Heater Voltage	Heater Current	Max. Peak Inverse Voltage	Peak Plate Current (Per plate) D.C. Ma.	Max. D.C. Heater-Cathode Voltage	Max. A.C. Plate Voltage (Per plate) RMS	Max. Output Current D.C. Ma.	Style
12Z3	126	0.3	700	330	350	235	55	Half-Wave
25Y5								
25Z5								
25Z6	25	0.3	700	450	350	235	75	Full-Wave
25Z6-G							Per plate	
25Z6-GT								
35Z3-LT	35	0.15	700	600	350	250	100	Half-Wave
35Z4-GT	35	0.15	720	600	350	250	100	Half-Wave
35Z5-GT	35	0.15	700	600	350	235	100	Half-Wave
45Z3	45	0.075	350	390	175	117	65	Half-Wave
45Z5-GT	45	0.15	700	600	350	250	100	Half-Wave
50Y6-GT	50	0.15	700	450	350	235	75 Per plate	Full-Wave
50Z7-G	50	0.15	700	400	350	235	65 Per plate	Full-Wave
117Z6-GT	117	0.075	700	360	350	235	60 Per plate	Full-Wave

Circuits make it possible to obtain a high D.C. voltage without a step-up transformer. Explained briefly, this is accomplished by alternately charging two or more capacitors to the peak line voltage, or very nearly so, and allowing them to discharge in series so that the total voltage will be the sum of the voltages appearing across individual capacitors. This action is achieved automatically by two or more diode-type rectifier tubes which perform the switching operation electronically.

The most familiar transformerless voltage multiplier circuit is the *voltage doubler*. The doubler is employed widely in A.C. operated midget radio receivers to obtain plate voltages approximately equal to twice the line voltage. Figures 2 and 3 show voltage-doubler circuits.

The circuit of Figure 2 is a full-wave

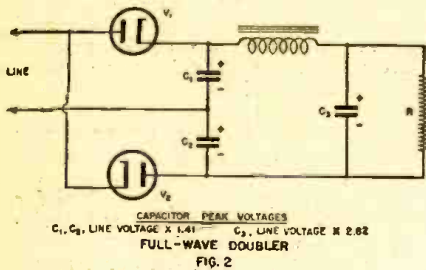

arrangement, also termed the symmetrical doubler circuit. This circuit operates in the following manner: When the plate of the diode V_1 is positive, current flows through that tube and charges the capacitor C_1 to a voltage equal to the peak value of the line voltage less the small drop through V_1 . The polarity of the charged capacitor is then as indicated in the diagram. During this half-cycle of line voltage, the plate of V_2 is negative and that tube can pass no current.

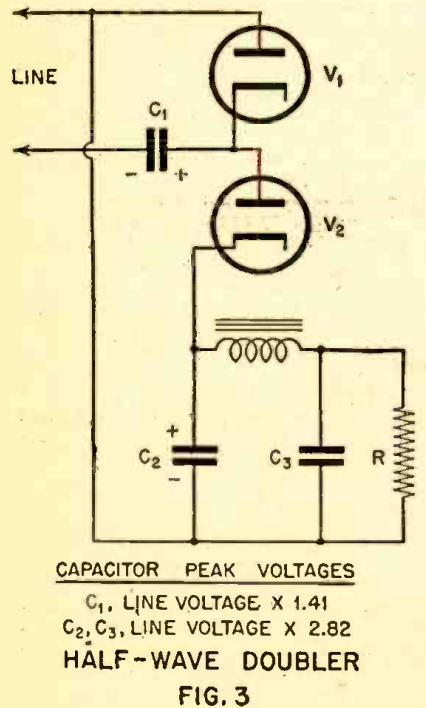

When the line polarity reverses, however, current will flow from the lower side of the line, which is now positive, through the circuit containing V_2 and C_2 and back to the upper side of the line. C_2 is then charged to a voltage equal to the peak line

voltage less the drop in V_2 , and its polarity is as indicated in the diagram.

Note that the two sides of the capacitors that are joined together are of opposite polarity, which means that if the capacitors did not discharge into the load circuit the voltage now appearing across C_1 and C_2 in series would be equal to twice the peak line voltage less the small drops through the two tubes. Hence, the term *voltage doubler*.

C_1 really discharges through the load resistance R while C_2 is charging. But the capacitor charge is not entirely dissipated in the load in the short interval before the polarity of the line returns to positive, a residual charge remaining in the capacitor. Consequently, the charging of each capacitor on subsequent positive half-cycles begins only at that instant when the instantaneous line voltage exceeds the capacitor terminal voltage due to the residual charge. The charging then continues until a value is reached equal to the line peak less the tube drop. The capacitor then discharges exponentially through the load, while the other capacitor is charging, until the drop across the load resistance (due to the capacitor discharge) exceeds the instantaneous line voltage.

The voltage presented to the filter is the actual potential difference between the positive terminal of C_1 and the negative terminal of C_2 . This value would have a possible maximum, under conditions of no load or

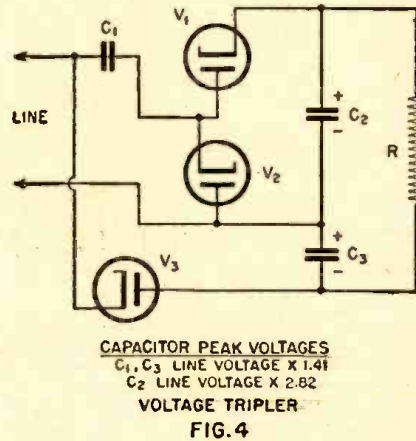

extremely light load, of double the line peak. The actual value, however, will depend upon how much current is being drawn by the load resistance.

Due to the separate discharge of C_1 and C_2 on successive half-cycles, both sides of the line-voltage cycle are utilized by this circuit. The voltage pulsations are accordingly at twice the line frequency although the ripple across each individual capacitor is at the line frequency. In this respect, the output of the full-wave voltage doubler resembles that of the full-wave rectifier. The full-wave doubler is therefore much easier to filter than the half-wave transformerless supply.

C_1 and C_2 are usually of the same capacitance for best results, although this is not an imperative requirement for circuit operation. These two capacitors are charged by separate diode units in the same manner as in the full-wave rectifier, and the increased output voltage afforded by the doubler circuit is obtained from the two capacitor voltages in series. Hence, the capacitor voltages, due to charging, never exceed the line peak and their voltage rating may be the same as recommended by the capacitor manufacturer for half-wave service at line voltage.

Figure 3 shows a *half-wave doubler*.

Operation of this circuit may be described in the following manner: When the plate of diode V_1 is positive, this tube passes current, charging C_1 with the polarity indicated and to a voltage equal to the peak line voltage less the tube drop.

When the line polarity reverses at the end of the half-cycle, the voltage due to the charge in C_1 will be added to the line voltage. V_2 passes current and C_2 is charged to a voltage equal to the line peak (less the drop through V_2) plus the voltage across C_1 . C_2 begins discharging into the load resistance as soon as V_2 begins conducting and consequently does not quite receive the full charge which would be equal to twice the line peak.

The "reservoir" capacitor C_1 is never subjected to higher voltage than the sum of the line peak and ripple voltages. Therefore, its voltage rating may be the same as the

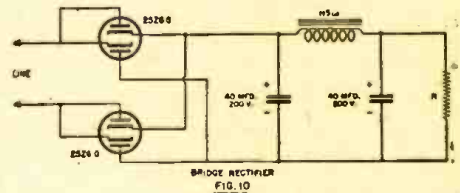

low value permissible for half-wave transformerless operation. C_2 , on the contrary, receives approximately twice the peak line voltage plus the ripple voltage and must be rated to withstand this total. C_1 may have reversed current flow, depending upon the capacitance and load resistance.

For the same value of load resistance, the half-wave doubler output is lower than that of the full-wave circuit. Likewise, the half-wave doubler, like the simple half-wave rectifier, is more difficult to filter, since in this circuit the ripple frequency corresponds to the low line frequency.

VOLTAGE TRIPLER CIRCUITS

Extending the principle of voltage multiplication still further, we show two *voltage tripler* circuits as Figures 4 and 5. The circuit of Figure 4 is essentially that of a conventional half-wave doubler and half-wave rectifier in series.

How this circuit supplies D.C. at three times the line voltage may be explained in this manner: When the lower side of the supply line is positive, diodes V_2 and V_3 pass current, charging capacitors C_1 and C_3 to the line peak less the drops in the two tubes. When the input cycle reverses, the voltage across C_1 combines with the peak line voltage and charges C_2 through V_1 to this total value. The voltage across C_2 is then very nearly equal to twice the line peak.

(Continued on page 49)

VOLTAGE TRIPLER
 INPUT = 112 V. RMS
 TUBES 2-2526G
 (CIRCUIT IN FIG. 5)

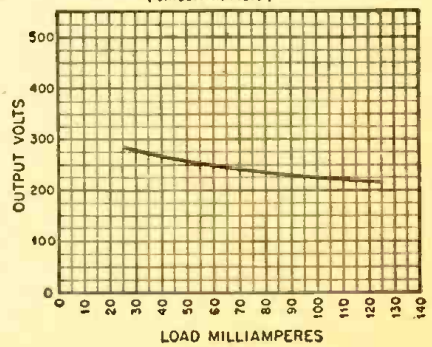

FIG. 6

FLIGHT RADIO SCHOOL TRAINS ENLISTED MEN



(Top) Students wiring a control panel; (center) trainee giving flight orders from a simulated ground station, and (bottom) an instructor inspecting tape at the Melville Aeronautical Radio School.

HUNDREDS of enlisted men are now being trained in ground and flight radio operation and in radio maintenance for the U. S. Army Signal Corps, the Navy, the Coast Guard, the merchant marine and the airlines at the Melville Aeronautical Radio School, in New York City.

These trained men, in the opinion of a high-ranking officer of the Signal Corps, are the types needed for the Officers Training School. Enlisted students remain on inactive duty while training and are sent to the various branches of service upon completion of a training period of from four to eight months.

Frank Melville, founder of the school, has passed the greater part of his life in radio work. He received his first radio license when he was thirteen years old. Now, at the age of thirty-one, he is one of the leading transoceanic flight radio operators, traveling to Ireland each month. In addition, he is directing what probably is one of the most specialized radio schools in the country.

This school has been accepted as the standard for the training of high-speed radiotelegraph and radiotelephone operators by the U. S. Army Signal Corps. It is also the official apprentice school for training employees of the major airlines. Only those holding amateur radio licenses may make application for connection with these airlines through advanced radio training at the school.

Mr. Melville believes that the future of aviation, which, in his opinion, will expand to almost unlimited horizons, depends to a large extent on the thoroughness with which men are trained in the principles of safety in operation, which in turn depends upon complete knowledge and mastery of essential equipment in flight use. Therefore he has planned the type of training, equipment and facilities for this highly specialized field accordingly. Instead of using "make-believe" equipment, he uses actual operation equipment such as are standard in the airlines. That actual operation of the equipment is the best way to learn aeronautical communications is Mr. Melville's firm belief.

In building up this plan, the school has taken over the equipment of one of the leading wireless companies and has also been aided by other branches of aviation—companies that believe in these methods of preparing men for this type of radio work. Instructors are top-notch men with years of experience in radio communications—several of them are also connected with leading airlines—and they are teaching high-speed telegraphy, airline radiotelephone, teletype, radio maintenance, radio theory, meteorology, and a number of inter-related subjects deemed essential for a thorough training course in aeronautical radio.

On any of the four large floors occupied by the school one hears the continual hum of activity. Radio receivers, transmitters, radiotelephones, teletype and maintenance departments are going at full speed day and night. A student learning to operate a radio station is giving orders to planes in flight, ultra-high-frequency receiver and precision monitor combined with a microphone on his desk. His 250-watt transmitter is similar to the latest airline ground station—its frequency is crystal controlled.

A young man, training for radio service with the Army Signal Corps gets basic instruction on direction-finders (see front cover), one of the most important phases of the flight operator's work. In another section of the building one finds a group of students—the Airline Procedure Class—operating radiotelephone and radiotelegraph circuits simultaneously. All reports are copied directly on the telegrapher's mill. The instructor acts as the pilot in flight, giving orders to each station. Each student is assigned a station. The pilot reports his position and receives instructions from the different stations, just as is carried on in airline communications. The microphones, we noticed, are operated by pressing a foot pedal, similar to stations at the airports.

(Continued on page 57)

SIGNAL CORPS TRAINING BEGUN AT ILLINOIS TECH

LITERALLY making Illinois Institute of Technology, Chicago, the electrical war-training headquarters of the Midwest, thousands of men—the largest such group at any private school in the nation—are studying electronics, radio, fundamentals of electricity and micro-wave techniques at that school.

This program is so important to the war effort that the United States Signal Corps is awarding commissions to all men who complete the most advanced phases of the work.

Some of the best power company engineers in the Chicago area have come back to school for special courses at Illinois Tech. The training is considered so important that Illinois Tech is making some phases of the work compulsory for its electrical engineering seniors.

Seven courses or types of work make up the complete program. Keynote of the whole setup is the training in the principles and operation of micro-wave or ultra-high-frequency techniques recently announced by Secretary of War Henry L. Stimson as the newest and most effective of the Armed Forces' secret communications and detection apparatus.

United States Signal Corps radio and electronics engineers, operators and technicians "by the thousands" will be trained annually at Illinois Tech for the duration, Major-General George Grunert, in command of the Sixth Service Command, said.

The program, which features the most complete electronics work being given anywhere in the Sixth Service Command—including the ultra-high frequency techniques—is rapidly reaching full operation.

Already students in all the various levels of radio study at the Chicago school are figured in terms of four digits. When the program reaches top capacity, at about the middle of the month, the continuous enrollment will be in the thousands, more than double the present number.

The phenomenal growth of this technical training program is especially significant in view of the fact that it is a new type of work, developed almost entirely since the Signal Corps began its expansion program.

All of the course of study had to be planned and designed by Col. C. N. Sawyer, of the Signal Corps, and Illinois Tech faculty members, under the direction of Dr. Jesse E. Hobson, head of the department of electrical engineering, himself a young electrical engineer who finished his own graduate work only a few years ago, since never before had ultra-high frequencies been a part of the standard engineering curriculum.

In addition to the micro-waves study—in which several hundred men are currently enrolled—the Illinois Tech program includes every phase of radio work from fundamentals on up to the advanced studies. Other groups now studying include an even larger number in "elementary radio engineering"—which precedes the ultra-high-frequency work—and several hundred others in part-time evening elementary study.

Also listed among the radio "war trainees" are Illinois Tech's electrical engineering seniors, for whom the micro-

waves work is compulsory. Like the special trainees, they will be eligible for Signal Corps commissions.

In addition to these groups—whose enrollments are expected to double within the next month—a new radio operator's and

code school will be opened by the Institute about September 15, to train a continuous enrollment of hundreds of men.

All these various classifications together will add up to a continuous enrollment of
(Continued on page 57)



One of the several hundred Signal Corps enlisted reserves receiving special radio studies at this Midwest school. He is working with Instructor J. C. Abener. The two pieces of apparatus with which they are working are a signal generator and a vedolyzer. (Above)

A student records the data supplied to him by a piece of test apparatus in the \$100,000 laboratory built by Illinois Tech staff members especially for the micro-waves courses. This multivibrator measures the frequency of oscillations of the ultra-high-frequency waves. (Below)

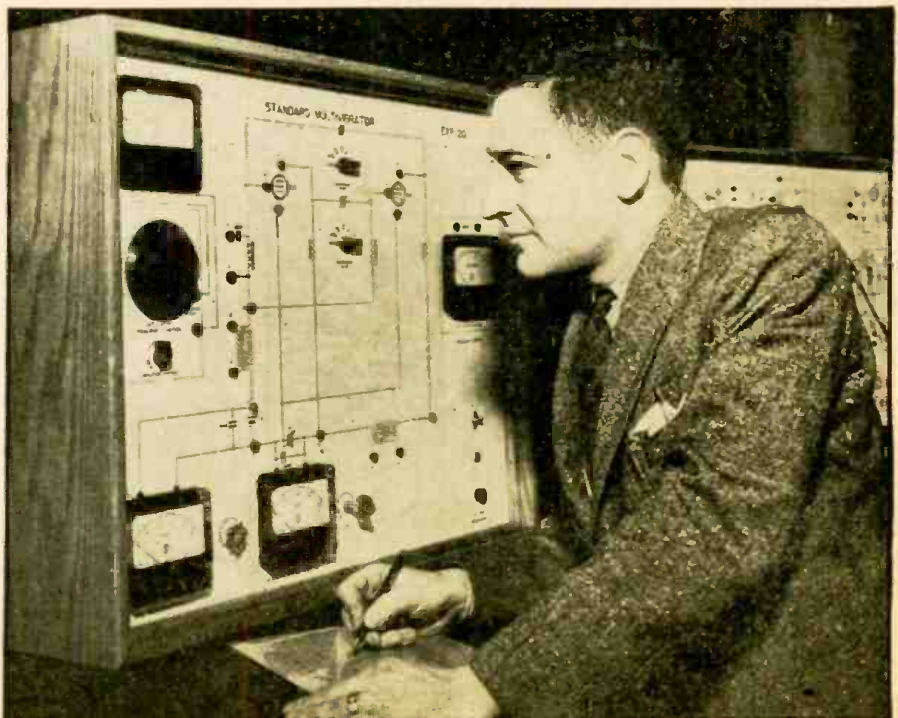

FACTORS CONTRIBUTING TO GOOD RECORDING

By R. A. LYNN

Engineering Department, National Broadcasting Company, New York

MANY variables are encountered in recording and reproducing transcriptions. Certain of these variables can be controlled by the setting of standards. Others can be controlled by a realization of the variables and consequent employment of a technique which reduces their magnitude.

It is the purpose of this paper to describe the operating characteristics of certain recording and reproducing components, and to give a few suggestions pertaining to the employment of good engineering practice in their use.

THE CUTTER HEAD

There is no particular problem with present-day equipment in obtaining the desired electrical and distortion-free characteristics in the amplifier chain from the microphone up to the input terminals of the cutter head. The cutter head, on the other hand, represents an item which is subject to great variation dependent upon its manufacture and manner of use.

The first step necessary in placing a cutter in operation is to have it engrave the desired frequency characteristic on the disc. This characteristic should not be an arbitrary one, but should follow some set of standards. The analysis of practically any standard frequency characteristic which has ever been proposed will show that it may be broken down to certain basic sections. The one to be discussed has, as a foundation, a constant amplitude section extending from the lowest frequency of 50 cps to 500 cps and a constant velocity section from 500 cps to 10,000 cps. The frequency 500 cps is therefore called the "cross-over frequency" indicating the transition from "constant amplitude" to "constant velocity." With this characteristic as a basis, any desired pre-emphasis curve may be added.

It may be well at this point to mention that the characteristic curves which are to follow have been plotted on a velocity basis. In the region from 500 cps to 10,000 cps we will encounter a curve which follows, let us say, the zero axis for the ideal condition since this is the constant velocity section. Below 500 cps is encountered the constant amplitude section; how-

SUMMARY—It is the desire, in the transcription field, that the reproduced quality be a facsimile of the original program. The recording unit, the disc, and the reproducing unit play important parts in achieving the desired results. A discussion of a few of the operating characteristics of these items and their effect on record quality is presented.

curve will be one which steadily diminishes in the region starting at 500 cps and progresses down to 50 cps. Furthermore, the characteristic must fall at the rate of 6 db per octave correctly to convert the expression from an amplitude basis to a velocity basis.

The existing characteristic of the cutter head is first determined and a comparison to the ideal characteristic is made. The

500 cps region is so "peaked" by the use of corrective electrical networks that the cutter characteristic is altered to be reasonably close to the ideal characteristic.

This electrical correction can be made anywhere in the channel equipment, provided it is always associated with a particular cutter. Under normal circumstances, all cutter heads of a given manufacture require similar compensators for the basic correction of the crossover point. However, minor irregularities in the form of high-frequency peaks are sometimes encountered which are not the same for all heads. Such irregularities can be corrected in the compensator. It is for this reason that it is advisable to avoid the use of a compensator with any cutter head other than that for which its circuit elements were adjusted.

METHOD OF MEASUREMENT

The characteristic of a recording head is measured by engraving various single-frequency tones through the spectrum on a disc. The pattern, when observed visually under proper light conditions is generally referred to as a "Christmas Tree" pattern. Since the frequencies in the region from 1000 cps to 10,000 cps are to be of constant velocity, the observed tone bands in this section should give rise to a light-diffraction pattern of equal band spreads. The departure from this condition is an indication of the variation of the recording-head characteristic from normal. The amount of change in level of the recording amplifier that is necessary to establish the flat condition is a measure of the original deviation.

Frequencies below 1000 cps are more conveniently measured by reproducing them through a pickup head which has been calibrated previously by means of a known tone record. (Several such records are available on the market—RCA T-2485-2, etc.)

Figure 2 is a photographic reproduction of a recorded tone disc. It will be noted that the flat-top section is the high-frequency portion of the spectrum. It is more satisfactory to use 78 rpm for recording the tone patterns due to the resulting sharper picture of the higher frequencies. The pho-

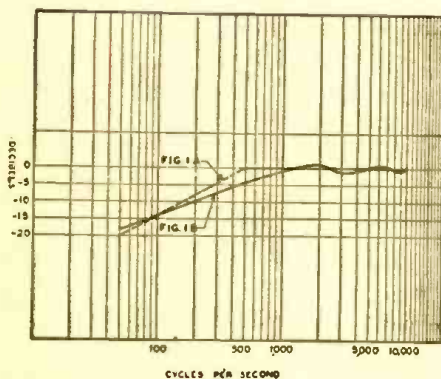
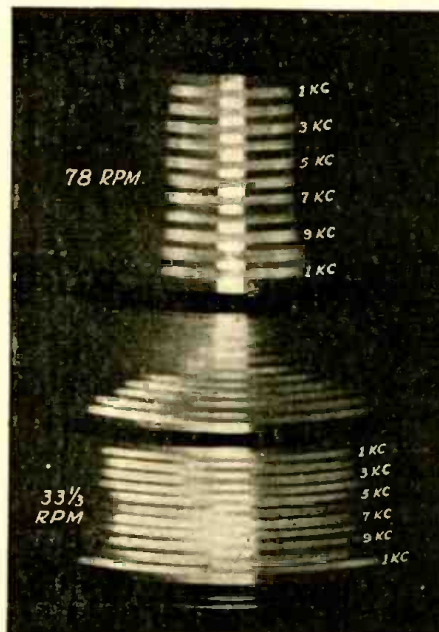

Fig. 1

ever, since the characteristic is to be expressed on a velocity basis, the equivalent

amount of correction to be applied will be apparent. Such a comparison is shown in Figure 1-a and Figure 1-b. Figure 1-a is the ideal characteristic shown with a sharp corner at 500 cps for the sake of clarity. In actual practice, all such transition points are permitted to "round off" to the extent of approximately 1.5 db to avoid the undesirable use of complicated multi-section compensators. Figure 1-b shows the characteristic of a particular present-day lateral recording head of the magnetic variety designed for transcription service. It is seen that the cross-over frequency is not well defined, but is located at approximately 1000 cps. Furthermore, a departure from constant amplitude is present below 500 cps in that the slope is approximately 5 db per octave, instead of 6 db. It is necessary, therefore, to resort to compensation. In the case under discussion, the

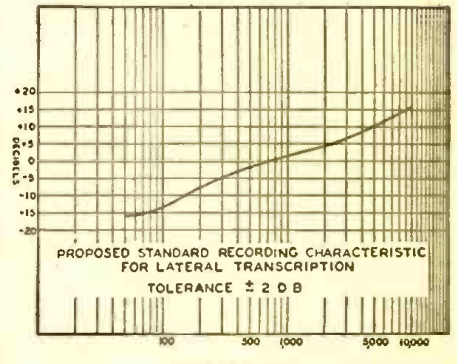

Fig. 3

tograph here presented shows the use of both 78 rpm and 33 1/3 rpm.

The relationship between the diffraction pattern and the engraved characteristic has been established mathematically by others and has been accepted by the art for many years. It is sufficient here to say that the band spread can be considered equivalent to voltage. Therefore, should a band spread be encountered for a particular frequency which has twice the linear dimension of the patterns generated by other frequencies, it is to be considered as being 6 db greater than the reference frequencies.

The term "band spread" as here used refers to the total width of the diffraction pattern created when modulation is applied, measured at right angles to a radial axis of the disc. It should not be confused with the thickness or duration of the band, which latter is purely a function of the extent of time the modulation is applied to the cutter head.

APPLICATION OF PRE-EMPHASIS

After the basic recording characteristic is determined, it is then relatively easy to apply the particular pre-emphasis curve required by the standards.

Figure 3 shows a proposed lateral-recording characteristic. It follows basically the construction outlined in the foregoing discussion. There is one difference, however; that is, a compromise has been made to accommodate simplified compensator design, especially for the playback circuit. It is noticed that no attempt has been made to preserve the sharp corner at the crossover frequency of 500 cps. The tolerance of ± 2 db permits the use of several frequency characteristics that are in use today. These represent standards for different organizations which account for a very large percentage of lateral recordings. The tolerance of ± 2 db appears, at first glance, to be excessively liberal, but it must be realized

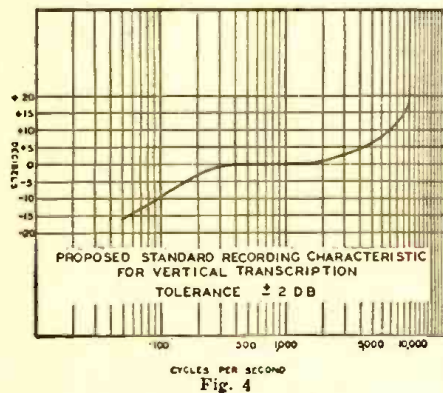

that this is the final recorded characteristic and, consequently, must absorb the various irregularities in the entire recording channel. The particular pre-emphasis as shown in this case is a 100-microsecond curve for the treble section. The curve is essentially constant amplitude below 500 cps and in addition there is a slight amount of pre-emphasis below 100 cps.

The pre-emphasis curve just mentioned is normally obtained from an electrical circuit consisting of L and R in series, said components having a time constant of 100 microseconds. The formula is $L/R=0.0001$, where L is expressed in henries and R is expressed in ohms.

Figure 4 shows the proposed standard recording characteristic for vertical recording. It differs from the lateral primarily in having a crossover frequency at 300 cps and a different rate of increase at the high

frequencies. Likewise, this characteristic represents a present-day standard for those organizations now making vertical recordings.

THE RECORDING STYLUS

Present-day recording styli are sapphire jewel points in practically all cases. They are ground into a wedge shape in such a manner that a shaving of lacquer (in the case of "instantaneous" recording) is removed from the disc. It is essential that the resulting groove be quiet upon reproduction. Sharpness of the point is therefore necessary. It is found from experience that if a burnishing edge is ground on a sapphire, a quiet groove results. This burnishing edge, however, if carried to extreme, will cause a loss of high frequencies due to the fact that a "bull-dozing" action results in the displacement or flow of the lacquer rather than its removal.

As will be seen later in the discussion of reproducers, the groove size is of utmost importance. A good fit must be obtained

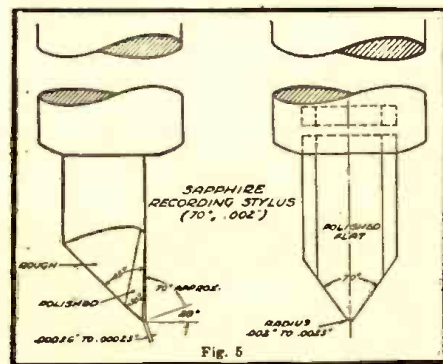

between the side walls of the groove and the reproducer point, in the case of laterally recorded discs, to avoid a chattering effect and consequent distortion. The tendency today is to use a stylus with a 70° included angle for the face. The radius of the bottom is approximately 0.002 inch. Figure 5 shows the essential dimensions of a cutting stylus which is in use for lateral-transcription work. These dimensions may be changed slightly upon further investigation by the N.A.B. Standards Committee.

In the case of vertical recording, it is preferable to use different dimensions since upon reproduction it is desired that the playback stylus track firmly on the bottom of the groove, utilizing the side walls only as a guide in following the pitch of the grooves. If separate vertical and lateral reproducers are to be used, both vertical and lateral systems could independently have their own standards. However, with the present tendency of using a combination reproducer with a fixed-dimensioned stylus, it is seen that the two systems will have to employ coordinated standards for the recording groove sizes. (This means that the vertical groove should be larger than the lateral to permit bottom tracking in the case of vertical and to permit tight sidewall coupling in the case of lateral. This problem is also under consideration by the N.A.B. Standards Committees.)

The groove depth is important in that if too shallow, the reproducer will not be tightly coupled to the disc and either distortion will result, or in extreme cases the reproducer stylus will actually "skip out" of the groove and slide across the face of the disc. On the other hand, if the groove depth is too great, the groove sidewalls will tend to be deformed or actually disappear on peak modulation with the result that

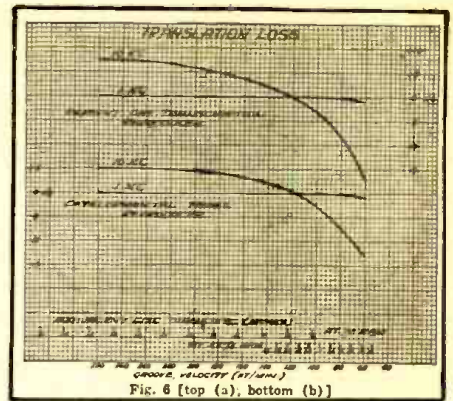

either echoes from the adjacent grooves will be heard, or in extreme cases the reproducing stylus will break through into one of the adjacent grooves. The proper groove depth is obtained when the ratio of the groove depth to the "land" width is 60-40 (at a pitch of 136 lines per inch).

THE RECORDING DISC

The disc used for recording plays a very important part in the eventual result. Unfortunately beyond selecting discs for optimum hardness (that is, discs not so soft as to permit the loss of high frequencies, nor so hard that high scratch levels ensue), and employing careful handling there is very little the consumer can do to vary the results as far as the finished recording is concerned. The manufacturer holds a great responsibility for such items which pertain to the disc dimensions, and to the lacquer coating. Many requirements could be mentioned which go into the fabricating of a good instantaneous transcription disc, but it should suffice to say that lacquer-disc manufacturing has made great strides in the past few years and, consequently, the market now offers satisfactory products.

THE REPRODUCER

An otherwise good recording can be ruined easily by a faulty reproducer. Present-day reproducers, of the transcription variety, are a great improvement over those of even a few years ago. Nevertheless, they still lack several desirable features. The stylus and its associated vibratory system unfortunately must have stiffness and mass. However, these elements now have been reduced to small values. At high frequencies, conditions are such that it takes considerable force to swing the stylus. The coupling between the groove and the stylus, and also the hardness of the disc is insufficient to make the stylus perform a faithful excursion of the groove contours. It is probable that the groove

(Continued on page 56)

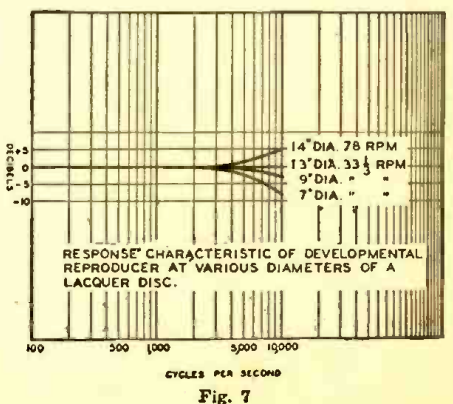

SOUND AS AN AID TO NAVIGATION

By WILLARD MOODY

ONE of the most interesting properties of sound is its relation to practical determination of distance by taking into account the difference between sound velocity and light velocity.

The velocity of sound varies according to the medium through which the sound is passed. Even air has a variable transmission characteristic since the temperature of air changes the character of the air and hence the velocity of sound.

At 0° Fahrenheit, the velocity of sound in air is 1,050 feet a second and it increases 1.1 ft. per sec. for each 1° F. rise in temperature. At 0° Centigrade, the velocity of sound in dry air is 331 meters a second and it increases 0.609 meters per sec. for each degree on the Centigrade scale. In Fig. 1, a curve is drawn which shows the velocity

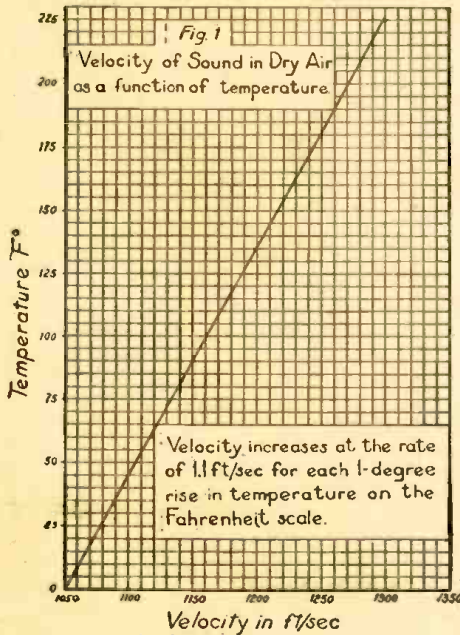

in terms of Fahrenheit temperatures.

The freezing point of ice on the Fahrenheit scale is 32 degrees and the boiling point is 212 degrees. Temperature at any given place on the earth's surface varies with the time of day, season and the latitude—to mention a few factors. The velocity of

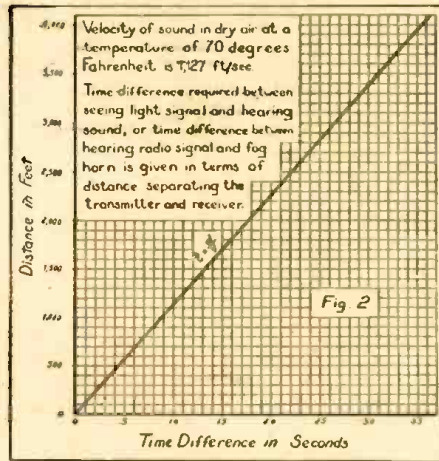

sound in air is independent of the pressure of air. Assuming that the temperature is 70° Fahrenheit, which would be normal for many conditions, the relation between the time difference of arrival of sound and light, or sound and radio signals, is given in Fig. 2. Of course, radio signals, like light, travel at approximately 186,000 miles a second and from a practical standpoint are instantaneous. The important point is how much later after seeing the light or hearing the radio signal, the audio or sound signal takes to come through the air. A practical case would be that of a lighthouse sending out a beam of light and following the flash of light with a blast on a fog horn. In some cases a radio signal is sent out, picked up by a receiver and a stop watch is used to check the time difference between the radio-wave signal and the sound-wave signal. Both signals start out simultaneously, the sound signal taking a longer time than the radio or light signal to arrive at the observation point.

If the distance separating the two points is in miles, the following formula may be used:

$$d = \frac{tv}{5,280}$$

where d is the distance, t is the time difference in seconds, v is the velocity in ft./sec. and 5,280 is a constant.

A simpler formula, where the distance is in feet is:

$$t = \frac{d}{v}$$

where t is time in seconds, d is distance in ft. and v is velocity in ft./sec. A curve for a velocity of 1127 ft. per sec., showing relation between time and distance for this velocity, is given in Fig. 2.

Because of reflection and refraction from strata of air of different temperatures, or from foggy layers, the sound of a fog horn may be entirely unheard by a vessel near the shore and in danger. If the lower portion of a horizontally moving sound wave is in warmer air than the upper part, it will travel faster and cause the wave front to change its direction, possibly causing it to curve upward. Also, currents of air, causing one part of a wave front to move at a different rate than other part, will distort the wave form and consequently the direction in which it advances will be altered.

Greater accuracy would be obtained if the sound wave were transmitted from the shore station through the water instead of through the air. The character of the water would not possess the uncertain properties of the air and better reliability should result. This principle of water transmission is used for determining depth in the fathometer. In this instrument, which works on the echo principle, or sound-reflection effect, a powerful audio oscillator sends out sound waves which go down to the sea bottom. At the start of the cycle of operation, a pointer passes a zero mark on a dial. The pointer is revolving at a known rate and carries a small neon tube on its tip. The depth in fathoms is read directly on the calibrated dial. The hydrophone picks up the reflected signal and makes the neon lamp glow, giving the indication. A lateral audio signal in the water, originating at the lighthouse or beacon station would be most useful.

The intensity of sound depends on the medium that carries it. The ticking of a watch can be heard two and a half times as far under water as in the air. Loudness depends on the intensity of sound produced by the sonorous body. The explosion of a volcano has been heard as far as 300 miles. In fresh water the velocity of sound is 4,700 ft./sec. and in salt water it is 4,765 ft./sec.

Devices for Air Raid Warnings

AS a result of the war, civilian authorities are eager to obtain information concerning devices suitable for air-raid warnings. Many requests for such information have been addressed to the National Bureau of Standards. In response to this demand, the bureau has undertaken a study of such devices and has tried to collect as much information as possible about the most desirable type of signal.

This work has not been completed, but as the need is urgent, all of the information and data which have been obtained up to the present time are presented in Letter Circular LC-685. As fast as additional data are obtained, supplements will be issued.

To aid in deciding on the type of warning device that should be used in any locality, it seems desirable to discuss a num-

ber of facts which have been listed under the following headings:

1. Frequency
2. Quality of sound
3. Loudness
4. Ease of coding signal
5. Type of device
6. Effects of weather

1. Frequency

In deciding on the type of signal that is to be used for air-raid warnings, one of the first considerations should be its frequency characteristics.

Experiments by Knudsen and others show that there is a decided absorption of sound at frequencies above 1,000 cycles per second, and as a result these higher frequencies are attenuated quite rapidly. This would indicate

that as the frequency is decreased the sound energy which is lost becomes smaller. Reasoning along these lines would indicate that the lower the frequency of the signal, the better would be its transmission.

However, the frequency of a warning signal should be such as to stimulate the nerve terminals in the ear. Work by Fletcher and many others has shown that at lower frequencies the ear becomes less sensitive; hence a signal having a frequency too low is not satisfactory.

For these reasons it is necessary to compromise between loss due to air absorption and loss in sensitivity of the ear.

Experimental work by the bureau in cooperation with the former Bureau of Lighthouses indicated that the most desirable fre-

(Continued on page 38)

Meissner RADIO KITS

ARE DOING THEIR DUTY
WITH THE ARMY SIGNAL CORPS!

... For Faster Radio Training



... Army sponsored Signal Corps Schools know the value of faster radio training... Meissner Kits are precision-built and engineered to give better results in basic radio instruction.
Illustration of actual Radio Kit instruction in Army sponsored Signal Corps School.
See your nearest Meissner Distributor

Meissner

MT. CARMEL, ILLINOIS

"PRECISION-BUILT PRODUCTS"

Wide-Range Film Recording Developed for Home Use

By H. W. KNETTELL

A new tape, 7 mm. wide, that carries two sound tracks, gives continuous two-hour distortion-free reproduction and is capable of extending the upper frequency limit to 16,000 cycles can be manufactured at sufficiently low cost to bring its use within the reach of the music lover.

A NEW type of recording for home use that literally pushes the upper frequency limit beyond any frequency previously achieved commercially has been developed in an upstate New York laboratory.

A series of tests conducted on this method indicates that existing amplifiers and loud-

speakers will have to be materially improved in frequency range and in distortion-free performance before anything approaching the amazing qualities of this method can be realized.

The music-lover who has longed for home recordings that would enable him to listen to a full-length symphony—unmarred by

needle scratch, uninterrupted by pauses for change of records or needles and with a crystal-clear quality equal in every respect to concert-hall performance—will be gratified to learn that his dream has at last become commercially feasible.

Famous musicians who have listened to their own and other artists' recordings admitted they could not detect the difference between the real and recorded music. "It's perfect!" they said. When Fritz Kreisler was unable to determine which of his two Stradivarius violins he liked better, he asked that recordings of his playing be made by this method.

The method utilizes sound-on-film reproduction, which is similar to talking-picture equipment but for the superior qualities of a new type of film. The process was developed by Andre Schoen, research engineer for the Ozalid Products Division of General Aniline Film Corporation, and utilizes a product of the company known as Ozaphane.

Ozaphane made its first public appearance at a dinner which was held last month at the Waldorf and was attended by about 300 guests. To demonstrate the reproducing fidelity of the new sound track, the most difficult of piano selections and modern orchestral compositions were played. A recording and reproducing system was built for it by J. A. Maurer, of New York. Although the sound film is capable of being reproduced to 16,000, the demonstration was given with the upper limit at 12,000. But even this was a distinct advance over other systems.

Although Ozaphane is similar in principle to the conventional sound film, there are many significant exceptions. The most basic of these is that the sound-track image, instead of being reproduced in a silver emulsion coating on the film, is embedded within the base material itself.

The base material is a cellophane tape treated with diazo compounds, which are light-sensitive organic dye substances. The dye is not a coating, but actually impregnates the tape.

The process of recording essentially is no different from that used in sound-on-film theater recording, but the quality of the recording must be considerably better to be able to take advantage of the particular properties of Ozaphane. The recording means utilized gives the variable-width double-track sound film such as is used in the RCA process, but this recording is made on a special high-resolution Agfa film. The first "photographing" of the sound track is made on a silver halite emulsion film. However, the customary reproductions printed from this or any other type of film cause what is known as "image spread." This is primarily due to the fact that the silver particles in the granular structure are incapable of yielding straight-line representations of the recorded audio frequencies. The jagged edge on a sound wave made by the usual methods therefore suffers from distortion caused by this image spread. If the

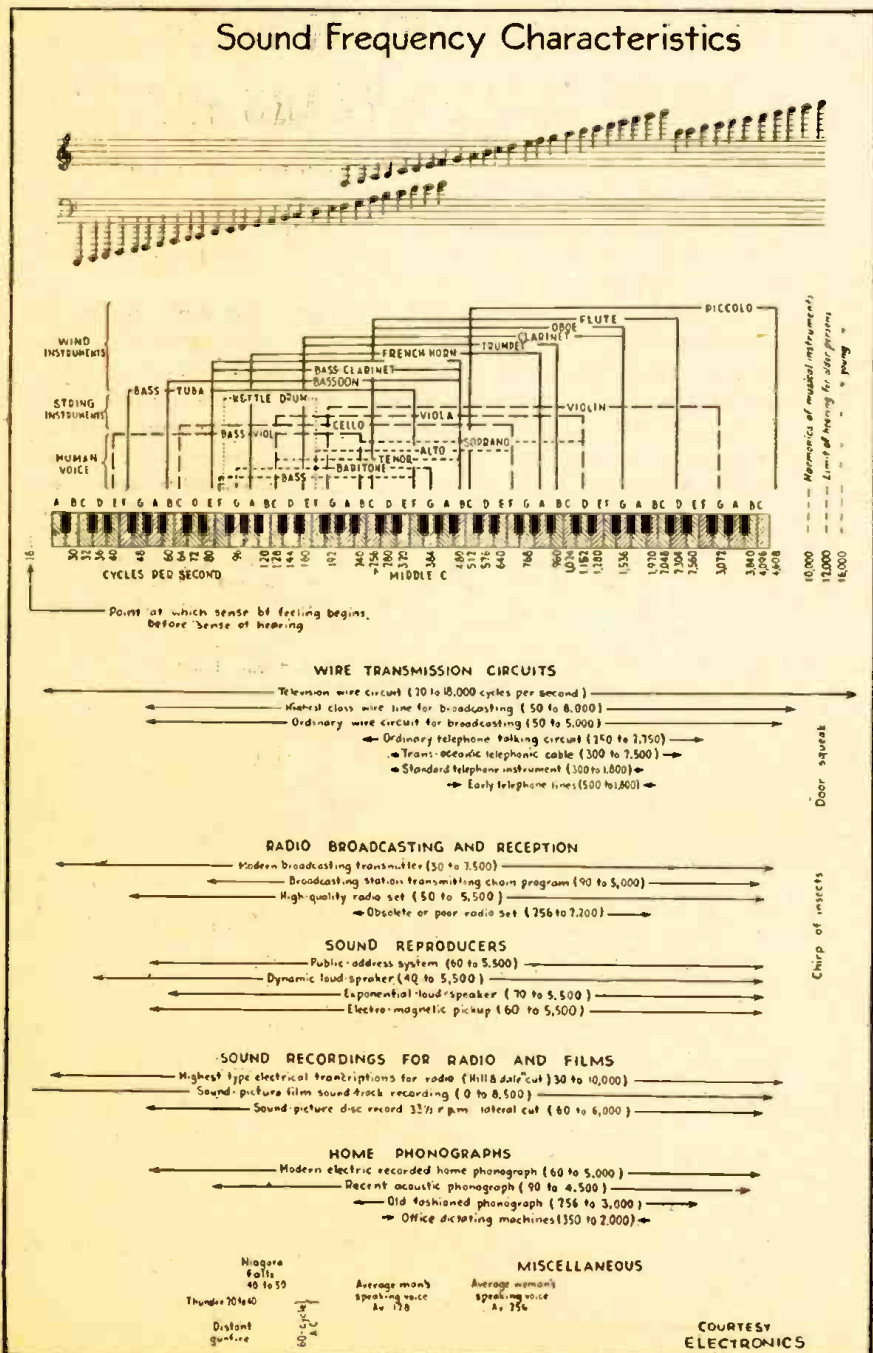

COURTESY ELECTRONICS

printing, however, is made on Ozaphane, the original sound-track image is improved due to an inherent characteristic in this material which gives "image contraction." This contraction has a cancelling effect and counteracts the distortion contained in the original film.

Because of the property of cancellation of distortion, it actually straightens out the jagged edges into sharp lines. Of course a microscopically small amount of roughness to the edge is duplicated in the print, but the distortion resulting from it yields harmonics above the 16,000-cycle upper limit.

Regarding upper-frequency limitations, another important characteristic of films may be compared. In ordinary sound film the upper limit is governed by the slit image which can be projected upon the film, and this in turn is limited by the size of the film grain. Ozaphane, on the other hand, has infinite resolution and no granular structure. Its frequency limitations would seem to be imposed upon it by the recording and reproducing means.

Further comparison with both records and silver film reveals that Ozaphane will not crack or scratch as will discs and films. The sound track, embedded within the cellophane, is not susceptible to the same injurious influences which attack the surfaces of ordinary film. There is no changing of records, since the longest symphony may be played through without interruption.

This material is much less costly than halite film and permits relatively inexpensive recordings to be made for use in the home. Mr. Schoen and his associates have recognized the need for improved recordings for the music lover and are intent on bringing the final cost down to the point where they will be competitive with disc recordings. The equipment will be made small enough to fit into the average floor-model radio-phonograph combination, which will also provide for disc reproduction. Were it not for the war, these units would be on the production line of a prominent manufacturer who was eager to put them on the market at once.

Aside from the excellent recordings that can be made by the Ozaphane process, the use of this marks another decided benefit to the music lover. A 10-inch magazine containing the Ozaphane film will give continuous music for two hours. Actually the film unwinds for the first hour, reverses and goes back to the beginning, meanwhile playing a second sound track. A process has been developed by a New York manufacturer of sound-on-film equipment which ingeniously reverses the film without the listener's knowing about it, so that a continuous recording is given even at this reversing point.

The tape is small and compact. A roll of silver film 1,000 feet long will play for 18 minutes, whereas a roll of Ozaphane of the same diameter will play 60 minutes, an increase of 233%.

In the demonstration the film was moved at the rate of 60 feet a minute, as compared with 90 feet a minute of motion-picture film. One unit made by Mr. Schoen used a 4-inch magazine and played for 40 minutes with the film moving at 40 feet a minute.

The film, comprising two recordings, one for each direction of film movement, is only 7 mm. wide. The width of each sound track is 2½ mm. The weight of a 10-inch magazine is about 7 ounces.

The basic materials are much less expensive. Although the first "photographing" of the sound track is on silver halite, all subsequent prints are made on cellophane tape and developed and printed in a single operation in ammonia fumes. This takes place at the rate of 80 feet a minute, and in daylight, without necessity for a dark room.

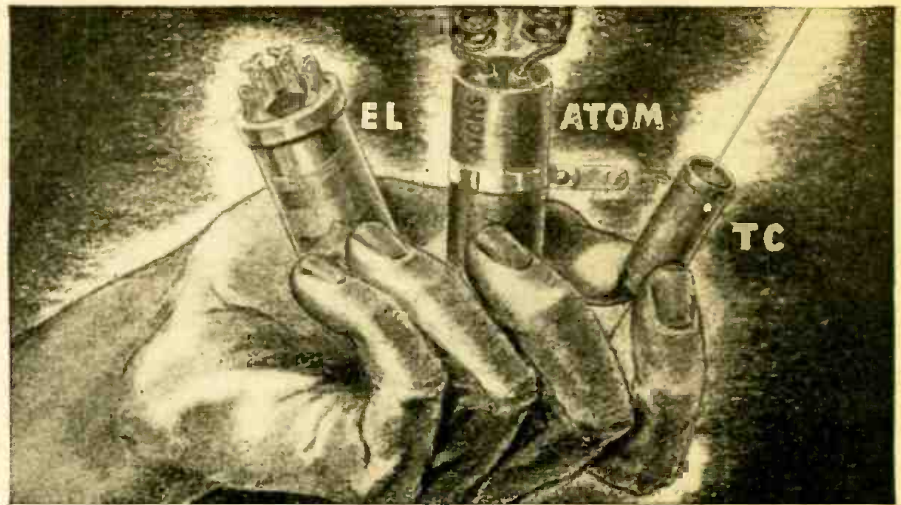

TODAY'S CONDENSER PROBLEMS WERE SOLVED YEARS AGO!

No matter how many condenser types war restrictions may make it impossible to supply... you're still in business as far as condenser replacements are concerned as long as you can continue to get Sprague Atom Midget Drys, Sprague EL prong-base Electrolytics, and Sprague TC Paper Tubulars.

Long ago, Atoms proved that they were the truly universal condensers—just the thing to replace any cardboard or can-type unit up to their rated values, and regardless of size. For higher voltages and wet condenser replacements, use EL's. For all tubular by-pass needs, use Sprague TC's—the most famous units of their kind in the history of Radio, and still the most dependable. These three types enable you to handle practically any condenser replacement job!

Practically all of Sprague's greatly enlarged facilities are devoted to war work, have been for a long time past, and will be until Victory is won. Although present jobber stocks of the above condenser types are largely complete, it is obvious that further production for civilian use must depend upon authorization from those in charge of the allotment of manufacturing facilities and critical materials.

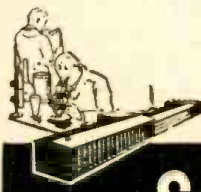

SPRAGUE PRODUCTS COMPANY
North Adams, Mass.

These aspects suggest economy in manufacture, and the possibility that this may have value in electrical transcriptions of all kinds will be apparent. To be exact, processed Ozaphane costs one-tenth what silver film costs to process.

Another reason for Ozaphane's faithful reproduction lies in the fact that the cellophane tape does not accumulate static charges of electricity. Static is a thorn in the flesh of the silver tape method, because it attracts dust particles and these in turn distort the sound. Absence of this difficulty in itself represents a long step toward better recording.

In making Ozaphane prints, several economies are provided. If a certain passage is badly recorded, technicians can go over one, two or a dozen bars of music and splice in a new piece. It is unnecessary to repeat the whole performance, which would be

(Continued on page 53)

RADIO-TELEVISION INSTITUTE

Not just another radio school, but a TRAINING ORGANIZATION well equipped with LATEST and MOST EXPENSIVE APPARATUS and staffed by PRACTICAL RADIO ENGINEERS who understand the various branches of RADIO, TELEVISION and the manifold uses of ELECTRONICS.

Our students quickly find profitable positions.

Resident course only. Inquiries invited.

Radio-Television Institute

480 Lexington Ave.
New York City

Licensed by the State of New York

RADIO DIRECTION FINDERS

By WILLARD MOODY*

THE radio direction finder is useful in navigation of ships on the sea and planes in the air, but in addition it has important duties to perform in obtaining bearings of unlicensed transmitters that may be used by enemy aliens. It is worthwhile, therefore, to review some of the simple properties of the loop antenna and to draw attention to certain principles and practices associated with direction-finding equipment.

The direction finder is based on the principle that radio waves from a transmitter will travel in an essentially straight line and that the loop will pick up a minimum signal if the plane of the loop is perpendicular or at right angles to the incident wave front, with the possible exception of fixed compass installations in aircraft which employ the basic Department of Commerce radio compass. This system depends for its operation on a cardioid pattern derived by means of a fixed loop and vertical antenna. In Fig. 1, a rectangular loop is illustrated. A radio wave of direction indicated in the drawing, has an electromagnetic flux which

cuts the conductor L_1 , inducing a voltage E_{ab} , proceeds further to cut conductor dc , inducing a second voltage which lags behind the first by the phase angle θ . The amount of this lag is proportional to the length of L_2 . The voltage induced in the loop is then represented by the vector diagram and is given by the formula,

$$V = \frac{2\pi EA}{\lambda} \text{ volts} \quad (1)$$

where E = field strength in volts per meter
 A = area of the loop

(provided θ is small)

V = induced voltage in loop
 λ = wave length in meters

The phase angle between E_{ab} and E_{dc} is,

$$\theta = \frac{2\pi l_2}{\lambda} \quad (2)$$

The induced voltage is proportional to the field strength multiplied by the area of the loop and is inversely proportional to the wavelength. The induced voltage for n turns will be n times as great, if it is assumed the loop dimensions are small in comparison with the wave-length. This means standing waves will not be present. The preceding formula assumes that the wave direction is incident to the plane of the loop. Where this is not the case and the angle of direction of the loop is φ with respect to the line of true minimum bearing, the phase difference will not be so large as is indicated by formula (2). Instead, it will be given by the following relation,

$$\theta = \frac{2\pi l_2 \cos \varphi}{\lambda} \quad (3)$$

and the induced voltage will be,

$$V = \frac{2\pi NEA}{\lambda} \cos \varphi \quad (4)$$

where V = induced voltage in millivolts

E = field strength in millivolts/meter
 A = loop area in square meters
 n = number of turns on the loop
 λ = wavelength of the signal
 φ = angle between direction in which loop is pointing and bearing of station.

If the loop is not square, equation 4 continues to hold true, provided that the areas

are identical in all cases. The term $\frac{2\pi nA}{\lambda}$

is known as the "effective height" since it determines the ratio of effective induced voltage to the field strength, when the loop is in line with the station or incident wave.

At right angles to the loop, at a point of minimum signal pick-up, the cosine of φ is zero. Assuming a square-law detector is used in the antenna input circuit (for ex-

ample, the first detector of a superheterodyne), the output meter on the direction finder will have deflections proportional to the square of the terminal voltage at the loop. If a readable deflection is obtained when the loop is displaced 10 degrees from the zero position, the theoretical accuracy is less than 2 degrees when taking the mean of the angular position for the same output-meter reading, the positions being not greater than 10 degrees on either side of the null, or zero, point. A highly sensitive and selective receiver is desirable for gaining sharp bearings.

The presence of a sky wave will detract from the accuracy of the measurements. This is encountered when working with

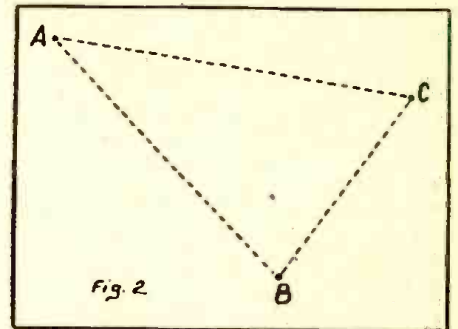

Fig. 2

high frequencies and is also observed on lower frequencies due to "night effect."

The effect of stray capacitance due to antennas on board ship or metal objects on board plane, productive of spurious reradiation effects which subtract from accuracy is, of course, well known. For this reason the loops are carefully balanced to ground by using a split stator condenser and, in addition, are shielded electrostatically. In navigation aboard ship, it is necessary to take into account that due allowance must be made for chart distortion before the navigator can plot the bearings obtained by radio, since radio bearings are true great-circle bearings. Before the navigator takes the plot from the regular compass rose of a Mercator Chart, a correction factor must be applied. Where the distance does not exceed 50 miles, this correction can be disregarded. The position of the ship obtained by dead reckoning and the position obtained by the radio direction finder result in a difference, between which, in the middle, is a new bearing called the middle latitude or middle longitude. The tangent correction is,

$$\tan \frac{\text{correction}}{2} = \frac{(\tan \text{diff. long.}) \times (\sin \text{middle lat.})}{2} \quad (5)$$

How a bearing may be taken is illustrated Fig. 2. The transmitter is located at point A and the ship takes a bearing at B, proceeds a definite and known distance in a straight line, B-C, and a second bearing is taken at C. Then, the distance b is given by the formula,

$$b = \frac{a \cdot \sin B}{\sin A}$$

To obtain the "sense" of the bearing, since in a loop the pick-up may be recipro-

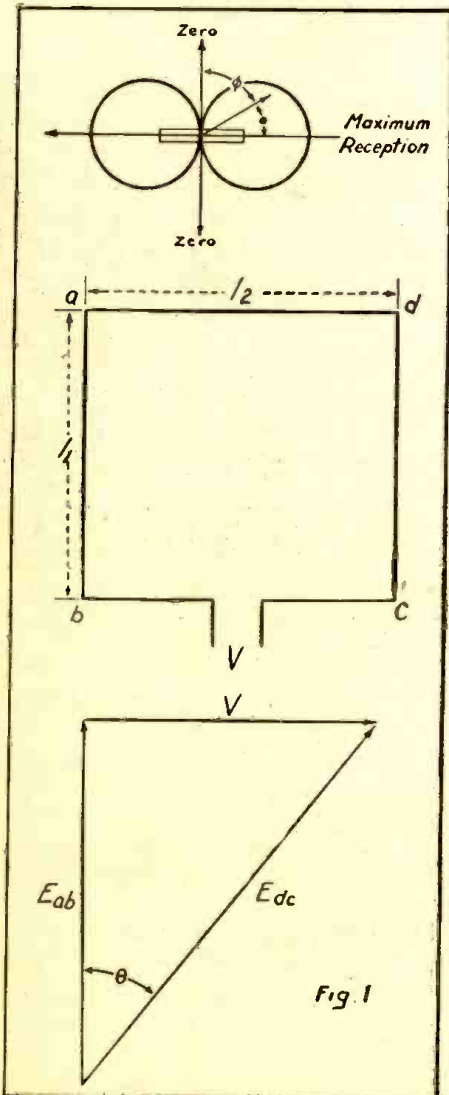
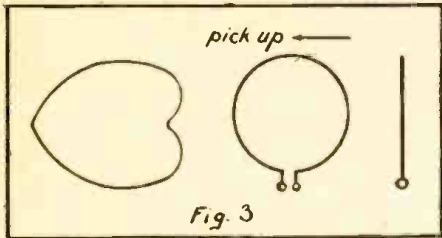

Fig. 1

*Instructor, commercial operator.

cal, a vertical antenna is used. After first obtaining a null, the sense antenna is connected to the loop or input circuit of the receiver and the signal will immediately gain in strength, if the direction of the incident wave is favorable. The pattern obtained is illustrated in Fig. 3. The result is heart-shaped, often termed cardioid.



This cardioid pattern principle makes it possible to employ a simple scheme for direction finding purposes. A loop can be installed in aircraft with the loop plane set at right angles to the fuselage or parallel with the wings. Then, when the pilot is flying the ship in the direction of an incident wave or station, a minimum bearing will be obtained. It is necessary that he swing the nose of the ship slightly off course to left or right from time to time in order that the bearing be checked.

A novel modification of this scheme was developed prior to 1927 by Dieckman and Hell in Germany and a practical version of it was exemplified by a Department of Commerce instrument. The cardioid pattern is alternately switched back and forth in direction. This system is employed in aircraft fixed loops. The audio rate of reversal of the pattern is about 1,500 cycles per second. The figure 8 pattern of the loop is stationary, as far as the indicating meter is concerned, but the difference in output from the two cardioid patterns which are reversed in polarity, operates a balanced vacuum-tube voltmeter circuit which moves the zero-center meter pointer to the left or right, depending on the line of flight with respect to the radio wave and the transmitter on which a bearing is being taken. Should the plane be heading opposite to the true course, or at variance by 180 degrees, a left indication would be obtained on the meter, and the opposite effect would also obtain. The compass does not operate on the principle of a minimum signal, in contrast to most others, which means that the range is greater and the signal-to-noise ratio better. Once set on a station it indicates continuously within 1 or 2 degrees.

The Kreusi Compass, developed by the Army, uses a similar idea except that reversal of phase switching takes place in the vertical antenna at an audio rate. A disadvantage is that it can not be used for voice broadcasts since switching is at audio frequency.

In the Navy Compass, a reversing cardioid field pattern is also employed but aural rather than visual indication is used. The signals are an interlocked *A* and *N* produced by a commutator geared to the engine tachometer shaft. The commutator alternately works two relays in the *R-F* coupling unit, causing superimposition in alternate phases of the vertical antenna pick up on the loop pick-up. Thus, to the left of true bearing an *A* will be heard, to the right an *N*. On course, signals are long dashes composed of the interlocked *N* and *A*. In the case of cross winds, this and similar types of direction finding instruments are at a disadvantage since the plane

must fly in a curved path, deviation being dependent on cross-wind velocity.

Compasses of the rotating loop type aboard ship and aircraft are used principally by the Coast Guard and Navy. The Navy has about 50 stations at entrances to principal harbors on both coasts. On the large planes equipped with a navigator, the rotating loop is practical.

In loops of the sort described, with cardioid pattern and switching, serious errors due to a dephasing action occur, and while the fault was properly corrected, it was, nevertheless, required that precise gang tuning of loop and antenna be achieved. A system which effectively eliminates this drawback is one employing a cathode ray tube. The directional and non-directional voltages are amplified independently and then combined at the cathode-ray tube. The vertical antenna works into its own *R.F.*, mixer and *I.F.* system and the loop antenna has its own similar channel. The loop voltage when amplified results in a variation or deflection of the horizontal beam of the scope, while the vertical antenna voltage acts on the vertical beam. With the loop adjusted for minimum pick-up, the horizontal line on the screen of the cathode-ray tube becomes a point and expands as the loop is adjusted for increased signal pick-up. Signals between maximum and minimum limits produce proportional effects in the case of vertical antenna or loop pick-up. The resultant effect is, of course, the vector sum of the voltages acting on the plates of the tube.

The trace produced by the vertical antenna inclines to right or left, depending on magnitude and phase of the voltage induced in the vertical antenna. The amount of inclination will be governed by the relative intensity of the voltage due to loop pick-up. When on the course, a vertical line is observed, but a left bearing will produce a left incline on the cathode-ray tube trace; a right bearing produces an inclination to the right on the screen. The figure may be changed to a straight line by adjusting a trimmer. The pattern obtained when directly over a transmitter is circular and would be obtained by an aircraft flying directly above a radio station. The loop antenna has a voltage 90 degrees out of phase with the vertical antenna resulting in the circular pattern.

The Simon Radio Guide direction finder employs two loops mounted at right angles. Operating in essentially the same way as a radio range, except for the fact that the instrument is aboard the plane, this type of finder unfortunately has not only 180 degree ambiguity but two 90 degree ambiguities as well. It is necessary to employ a sense antenna for ambiguity determination. This sense antenna is switched in or out of the circuit, as needed. The receiver is a dual type employing two sections of substantially equal sensitivity. Occasionally, it is required that the sensitivity be adjusted when approaching or leaving a station.

Indication of direction is provided by two crossed needles at the intersection of these needles. If the indication is right, the needles cross to the right; if left, the needles cross to the left. The center reference line is equivalent to "on-course." The instrument is calibrated so that the station's direction in degrees of the plane's bearing may be read up to about fifty degrees on either side. In some installations the dual type loop is rotatable by means of a suitable wheel.

Any radio operator who has had experience aboard ship with direction finders knows that changes in the metal in the vicinity of the loop will seriously affect the

(Continued on page 41)

RADOLEK- Headquarters For Essential REPAIR PARTS



Thousands of progressive servicemen rely on Radolek for their complete requirements of repair materials. Make Radolek your dependable source for essential replacement and repair parts—tubes, condensers, volume controls, resistors, transformers, etc.—all at lowest prices.

Radolek understands service problems—gets delivery to you in double-quick time. Buying from Radolek means Greater Values, Better Service and More Profits. The big Radolek Radio Service Guide is FREE for the asking. Send for your copy today!

RADOLEK P. A. SYSTEMS FOR EVERY REQUIREMENT



Thousands of successful Radolek P.A. installations are proof of quality, superior design and top performance. Complete systems for permanent, portable or mobile use—wide choice of microphones, speakers and related equipment. Radolek P.A. Systems give you more for your money in Performance, Styling, Dependability and Reserve Power. Select the P.A. apparatus you need from Radolek's big FREE catalog.

RADOLEK REPAIR SERVICE

Let Radolek repair your damaged or burned out transformers, coils, speakers, test equipment, etc. Many items cannot now be replaced and therefore repairing is the only alternative. Trained craftsmen, using precision tools and factory methods, assure perfect jobs equal to new. Write for prices or better still, send in any article to be repaired. It will be handled promptly.

FREE!



**SEND FOR NEW FREE
RADIO SERVICE GUIDE**

**RADOLEK CO., Dept. C-71
601 W. Randolph St., Chicago, Ill.**

Please send the Big FREE Radio Service Guide.

Name

Address

DEALER SERVICEMAN SOUND ENG

SAVE AT RADOLEK

IN-PHASE AMPLIFIER

Designing a Non-Phase-Reversing Stage

By R. C. WHITEHEAD

THE ordinary resistance-capacity amplifying stage has an output voltage which is 180 degrees out of phase with respect to the input voltage. In the design of vision-frequency amplifiers, pulse-generators, multi-tube oscillators, etc., it is sometimes found that, while sufficient gain can be obtained with a given number of tubes, this combination produces the wrong number of phase reversals. To avoid adding a tube, the gain of which is not required, one of the stages can be made into a non-phase-reversing stage.

Fig. 1 shows the fundamental circuit of a non-phase-reversing stage. Instead of the cathode being connected to ground and the input being applied between grid and ground, the grid is grounded and the input is applied between cathode and ground.

INPUT AND OUTPUT VOLTAGES ARE IN PHASE

In Fig. 2 is shown the circuit of a practical non-phase-reversing stage. Because the input and output voltages are in phase, and because the grid acts as a grounded screen between input and output,* a triode tube can generally be used in cases where otherwise it would be necessary to use a pentode.

The condenser C_1 and the resistance R_3 have been introduced in order to avoid passing the DC component of plate current through the source resistance R_1 . If R_1 is high in value and a wide frequency band is to be covered, then C_1 and R_3 cause design difficulties, and they should not be included unless absolutely necessary. If R_3 is made high then the voltage available for operation of the tube is reduced. If R_3 is made low, then C_1 must have a low reactance at the lowest working frequency, and if this frequency is in the neighborhood of 50 cycles, then, as both sides of C_1 are at high signal potential, the stray capacity between it and ground will influence the design and performance at very high frequencies (e.g., 3 megacycles).

DESIGN CONSIDERATIONS

Since the cathode has been taken up above ground potential (as regards DC), so also must the grid be taken up above

*"Journal of the Institution of Electrical Engineers" (London), September 1939. Description of Series Amplifier in the Standard Telephones transmitter.

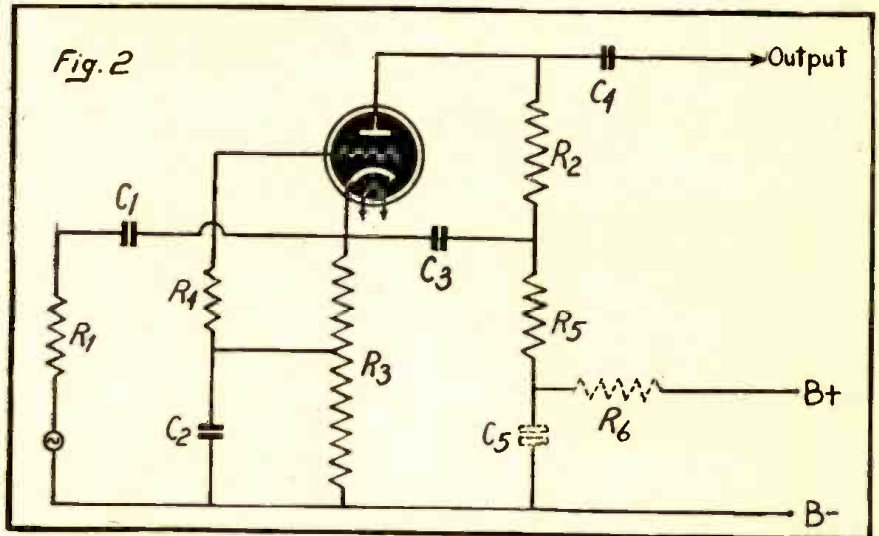
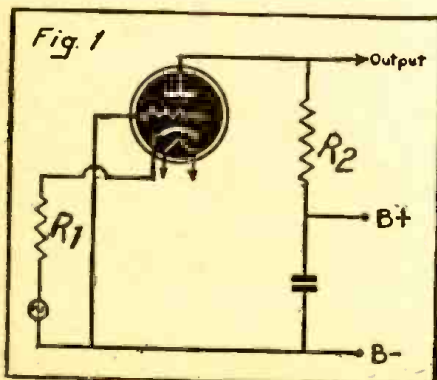

ground potential by the same amount, less the amount of grid bias required for normal operation. This is most conveniently done by connecting the lower end of the grid leak to a tapping on R_3 . The grid condenser C_2 and the grid leak R_4 can have normal values.

In this circuit the plate filter condenser C_3 is shown connected to the cathode. The alternating component of plate current does not therefore pass through the source resistance R_1 , and negative feed-back and consequent reduction of gain are avoided.

When selecting a condenser for the C_3 position an electrolytic type should be chosen only if the normal leakage current will not upset the performance of the circuit.

Examination of Fig. 2 reveals that both R_2 and R_5 are effectively in parallel with R_3 . Normally R_5 should be equal to R_3 .

The load resistance R_2 and the filter resistance R_5 should be made as high as is consistent with other requirements in order that the capacity of C_3 may be kept to a minimum because the stray capacity of C_3 to ground is effectively across R_3 .

Supposing that the B supply voltage contains some residual hum, and for the moment ignore the components shown dotted in Fig. 2. In an ordinary amplifier the resistor-condenser circuit acts also as a filter circuit.

However, in the circuit of Fig. 2 this is not so. If the reactance of C_3 at the hum frequency is small compared with R_1 plus R_3 , then the hum volts present in the plate-supply system are only reduced in the proportion $R_1 / (R_1 + R_3)$ and these hum volts are applied to the cathode or input of the stage and are thereby subject to its full amplification. The remedy is to ensure that the hum voltage is small at the top end of R_3 . This is done by adding C_4 and R_6 .

REDUCING PLATE-VOLTAGE VARIATIONS

Variations in plate voltage occurring at very low frequencies (a few cycles per

second) may also find their way to the cathode and these are not entirely removed by C_2 and R_6 . If these are troublesome they may be reduced by reducing C_3 or C_2 . Reduction of the former will increase the bass response, reduction of the latter will decrease the bass response.

The grid leak of the succeeding stage (R_1) should have a value which is high compared with R_3 multiplied by the stage gain.

TUBE MAY REQUIRE SEPARATE HEATER WINDING

If the cathode-ground volts exceed about 30, the tube should normally have its own heater winding. A compromise may, however, be effected by connecting a common heater winding to a potentiometer across the B supply, and arranging for the potential of the heaters to be midway between the extreme values of cathode-ground potentials of the various tubes.

The input capacity of the stage comprises the following:—(a) Cathode-heater capacity. (b) Cathode-grid capacity. (c) C_1 and C_3 stray capacities to ground. (d) Stray wiring capacities.

It will be seen that the input capacity of this stage is higher than that of a normal stage.

Finally a successful design can be best achieved by arranging the circuit as follows. These notes apply particularly when covering a very wide frequency band. (a) Insert the non-phase-reversing stage at a point where the output impedance R_1 and the output voltage of the previous stage are both low. (b) Avoid the use of C_1 if possible. This can be done if the previous stage is a cathode-follower. (c) Make R_2 as high as possible without encountering loss at the highest operating frequency. (d) Make R_3 and R_5 as high as possible without allowing the tube to be overloaded. (e) Make C_1 and C_3 as low as possible without encountering loss at the lowest operating frequency.

—Wireless World, London.

3-IN-ONE MULTITESTER HAS WIDE RANGE OF APPLICATIONS

Radio City Products Co.
127 W. 26th St., New York City

MAXIMUM sensitivity, flexibility and utility are combined in this new vacuum-tube multitester. This instrument, designated as Model No. 662, is an electronic voltmeter, ohmmeter and capacitometer in one, with an extremely wide and useful range of applications in laboratory and production-line tests, service work, etc.

It is a vacuum-tube voltmeter on AC readings—not a copper oxide rectifier type and it furnishes capacity readings directly in microfarads, with a measurement ratio

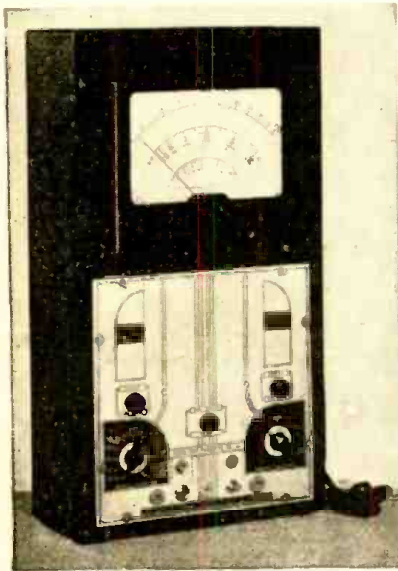

of 40,000,000 to 1. In designing this multi-purpose instrument, RCP engineers eliminated danger of shock on low-capacity measurements. There are no test leads to short, and no resetting is necessary when changing ranges. The meter cannot be damaged by accidental connection across a live resistor or by using a low range on high readings. Error due to line voltage fluctuation is eliminated by a VR105-30 regulator tube and associated circuits.

This model employs a sloping panel and a 4½-inch meter but an upright-style companion model (No. 662-V-7) with a large 8½-inch rectangular meter is also available. Both instruments have similar performance characteristics and are furnished with leads and large, readily accessible batteries, tubes and pilot light. The case is finished in crystalline gray.—Radio-Craft

THREE AND ONE-HALF INCH METERS

Westinghouse Meter Division,
Newark, N. J.

FOR radio transmitters, control panels, industrial test units and general test work in electrical laboratories a new line of miniature panel instruments is announced by Westinghouse Electric and Manufacturing Company.

Direct and alternating current, thermocouple and rectifier types of the three and one-half-inch class for indicating volts and amperes are made with a chassis construction permitting only a change in cover to make up square, circular, flush or projection type instruments.

Full-scale readings as low as 20 micro-

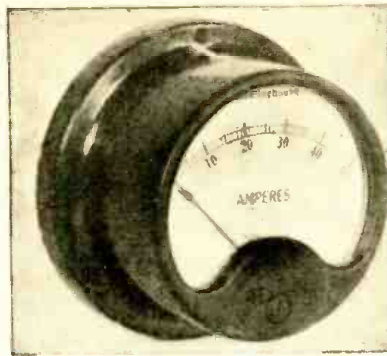

amperes are available for D-C measurement. Self-contained ammeters to 100 amperes, D-C and A-C, and voltmeters up to 500 volts A-C and D-C are also available. Higher ratings may be obtained by using resistors, shunts, or transformers.

On rectifier instruments the dial is calibrated in root-mean-square values with a sensitivity of from 1,000 to 5,000 ohms per volt. These are used for measuring A-C values when low energy consumption is important.

Thermocouple styles are available with either self-contained or external thermocouples developed for maximum overload and stability and are used for measuring radio-frequency currents. Frequency errors have been reduced to a minimum, and the overall design is balanced to give the minimum capacity or inductive errors.

Features common to all instruments in this classification are permanent white dials, high torque to white ratio, and Moldarta cases.

Additional information may be obtained from the company.—Radio-Craft

EXTRA-HEAVY DUTY 50-WATT POWER RHEOSTAT

Clarostat Mfg. Co.
285 North Sixth St., Brooklyn, New York

THIS new 50-watt rheostat is virtually identical to the previously introduced 25-watt unit, except for its larger size. The resistance wire is wound on an insulated metal core which distributes the heat at

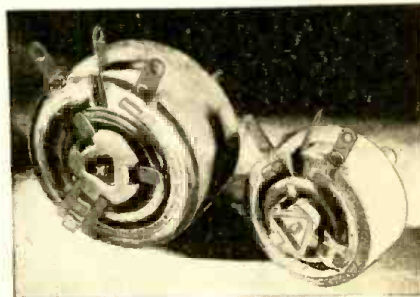

intermediate rotational settings. The resistance element is firmly imbedded in a ceramic housing with an inorganic cement, resulting in a solid thermal mass. A graphited-copper contact shoe rides the collector ring and the winding, assuring two positive sliding contacts. Contact pressure is provided by a helical spring concentrically mounted around the shaft, the action of which is evenly distributed by use of a tripod-type contact carrier. The contact is insulated from the metal shaft by a center ceramic insulator, thus providing a "dead" shaft and mounting bushing. These rheostats are available in any resistance values up to and including 10,000 ohms.—Radio-Craft

AIR-RAID SIGNALLING CONTROLLER

Automatic Temperature Control Co., Inc.
34 East Logan Street, Philadelphia, Pa.

DESIGNED to supplant manual methods for sounding "Alert" and "All Clear" air-raid signals, this new unit will automatically control operations of motor sirens, air or steam sirens, bells, lights, or any standard signal device in compliance with official civilian defense standards. Housed in a dust-tight, sheet steel case, 14 ins. x 14 ins. x 5 ins., and is supplied for either flush or surface mounting positions, the controller embodies the following construction features: Indicator lights show whether



"Alert" or "All Clear" signal is in effect; a 3-pole contactor used in the standard construction will handle siren loads up to 25 Amperes at 110 Volts, A.C. non-inductive; a toggle switch provides manual operation when desired; it is rated for operation from 110 or 220 volts, 25, 50, or 60 cycles, and it can be supplied with an automatic throw-over inverter and stand-by battery for insuring operating in the event of A.C. power failure. An instruction plate is mounted on the front of case.—Radio-Craft

FERRULE RESISTORS

Ohmite Manufacturing Company
4835 Flournoy Street, Department 3M
Chicago, Ill.

THESE Ohmite ferrule resistors were designed for easy interchangeability without any need for tools. An even winding of resistance wire on a ceramic core is protected by vitreous enamel coating. The wire is terminated on metal bands, or ferrules, which permit mounting in fuse clips. Ferrules are cup, sleeve, or cartridge type.

Ceramic cores with special coating are available which will withstand temperature shock tests of repeated immersions alternately in ice-cold water and hot water. Protective coatings which will pass salt water immersion tests are also available.

The ferrule type of resistor is particularly

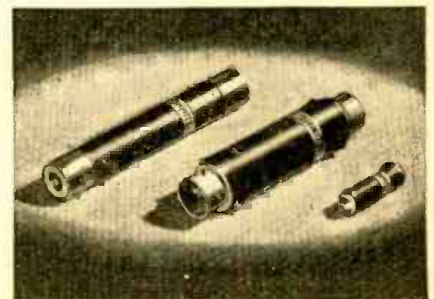

applicable for use in the Navy, in the Signal Corps, on Army aircraft and on railroads. Units may be obtained in a wide range of sizes.—Radio-Craft



Northern Radio Laboratory
3927 East Lake Street
Minneapolis, Minn.

"We have been using N.U. products since their inception. They have an aggressive merchandising plan we feel all dealers should avail themselves of. After 22 years in the radio business, we find National Union's helps have always been an asset to us.
A. H. WOLFE

WHERE YOU FIND
NATIONAL UNION
YOU FIND BETTER
RADIO SERVICE

PREMIUM
Quality
TUBES



BATTERIES



CONDENSERS

also *Transmitting tubes, panel lamps, cathode ray tubes, exciter lamps, sound equipment, photo electric cells, sound accessories, dry batteries, flashlight bulbs.*

NATIONAL UNION invites . . .

All radio service dealers to enjoy the benefits of the N. U. Shop Equipment Plan. The latest in tube testers and test equipment are available to you . . .

More than 60,000 completed deals prove the success of this plan. Investigate now.

Ask Your N. U. Distributor or Write



NATIONAL UNION
RADIO Corp.
57 STATE ST., NEWARK, N. J.

DEVICES FOR AIR RAID WARNINGS

(Continued from page 30)

frequency range for warning signals lay between 200 and 500 cycles per second. More recent work, which has been done on this present program, where shorter distances are involved, indicates that this upper limit might be raised to 700 cycles. (A 200-cycle note is about 2 tones below middle C, and a 500-cycle note is about an octave above middle C.) Surveys of signals in Boston and by the Northern Electric Company, Ltd., in Canada, confirm the bureau's findings that signals in this frequency range carry better than those having frequencies outside this range.

Another reason for choosing a signal with a comparatively low frequency is that the signal should be heard inside buildings. Studies made by the bureau on sound transmission through different types of building construction indicate that the average transmission loss of sound through such structures is about 8 decibels less at 200 cycles than at 1,000 cycles, and therefore a low-frequency sound is more likely to be heard inside a building than one of high frequency.

Low-frequency sounds also give a better coverage within a definite area, as buildings and natural obstacles produce less of a shielding effect than when a higher frequency is used. Also, directive effects caused by horns and other radiating surfaces are considerably less when a low frequency sound is used.

2. Quality of Sound

Having chosen the band of frequencies which is most likely to be heard, consideration should be given to the quality of the tone; that is, should it be a pure tone or should it be a complex tone made up of inharmonic components. Tests again show that an inharmonic combination of tones or a pure tone which is being constantly varied in frequency arrests the attention more quickly than a pure tone or a tone with overtones which are exact harmonics of the fundamental. Also, a combination of tones which are separated by a half octave or more can be selected which will sound louder than a pure tone which has the same amount of energy. If, in addition to the use of two tones, these tones can be varied in frequency the signal becomes very distinctive.

The character of the signal should also be such that it cannot be confused with the signals used by fire trucks, ambulances. Moreover, it should not be similar to surrounding noises, since these would mask the warning signal.

3. Loudness

To be heard above other noises, it is necessary that the signal be sufficiently loud. There is very little information to indicate how loud a signal should be, but it would seem desirable that the loudness level of the signal should be at least equal to the loudness level of the noise at a point where the signal is to act as a warning. (In very quiet areas, the signal, of course, should be louder than the surrounding noise.) In areas where there is considerable traffic the average noise level is 80 decibels or more. In a residential area, off arterial highways, the average noise level is approximately 60 to 70 decibels in Washington, although in some very quiet areas this level may be as low as 50 decibels.

If a signal level of 80 decibels is chosen as a minimum level for noisy locations and 70 decibels as the minimum level for residential districts, there will be a positive warning to persons out-of-doors and probably to anyone located in an outer room with windows. It is unlikely, however, that

such signals will penetrate rooms in the interior of a building.

To obtain signals of this level will require a considerable acoustic output, and it becomes necessary to consider the economic side of the question so as to decide whether a large number of small signals placed close together would be more economical than a few large signals spaced considerably farther apart. The answer to this question might be very different in different localities. This subject will be discussed further under parts 5 and 6.

It is the bureau's belief that in a downtown section, where the buildings are continuous and high and the streets are narrow, relatively small signaling devices, placed at street intersections, might give the best coverage. The number of intersections between signaling devices would depend on the size of the signaling device, and whether locations could be worked out so as to give uniform sound coverage for all streets.

For other locations where a uniform coverage is desired in all directions, it is believed that a device which will give a signal level of approximately 110 decibels at 100 feet will give, on the average, a satisfactory warning signal up to a distance of one-quarter mile if the average noise level does not exceed 80 decibels, and up to one-half mile if the average noise level does not exceed 70 decibels. If the signal strength is 100 decibels at 100 feet, these distances will be about one-half as great, and for a level of 120 decibels at 100 feet the distances could be doubled, but the uncertainty due to weather conditions will be somewhat greater at these longer distances. This point will be discussed further under 6.

The above statements are rather general and may not apply exactly to any given location. The distribution of signaling devices in any city is an individual problem, and it may be necessary to make trial installations at some points before the best results can be obtained.

4. Ease of coding signals

A signaling device should be chosen which can be easily operated so as to give coded signals.

5. Type of device

In considering the type of device which should be used, it is desirable to make a survey of existing facilities. An attempt should be made to lay out a warning system which will require the purchase of a minimum amount of new equipment and still give an efficient warning. For instance, if there are steam plants which have steam up all of the time, a steam whistle or steam siren might be used. In many cases a factory might have a whistle or siren, and it would not be necessary to purchase additional equipment for that locality. In many other locations it might be possible to use air horns. The necessary air to blow such horns might be obtained at a filling station or a bus terminal, provided an extra air tank were installed. There might also be other factors which could be taken advantage of in any given city to lessen the amount of equipment which it would be necessary to buy.

6. Effects of weather

One of the most important factors in the propagation of acoustic signals over large distances is the weather, or more specifically the humidity, wind and temperature varia-

(Continued on page 53)

HOW TO MAKE A 2 3/4 x 4" RECEIVER

By IRVING MINTON

GONE are the days when experimenters sought to make sets larger and more elaborate. The tendency today—based on scarcity of parts, among other factors—is to make sets smaller and better, using, of course, only currently available materials.

Until the introduction of microtubes, which were introduced principally for hearing-aid devices, tubes required so much space that anything resembling vest-pocket receivers couldn't possibly be accomplished.

The last issue of *Radio-Craft* (Aug.-Sept., page 723) disclosed that a miniature four-tube receiver was described at the recent I.R.E. convention. Although I have not seen this receiver, I believe that *Radio-Craft* readers will be interested in knowing that I was able to construct a complete receiver using three microtubes and an improvised loudspeaker, all of which, includ-



ing an A battery and a 45-volt B battery, fits into a single box measuring 2 3/4 x 4 inches.

Lest there be any misunderstanding, I should like to state that the circuit diagram did not originate with me. In fact, it was designed by L. M. Dezettel, whose instructive articles are familiar to *Radio-Craft* readers. Whereas, Mr. Dezettel's receiver (described in *Popular Mechanics*) was built in a box measuring 3 x 3 x 2 1/2 inches, the A and B batteries and earphones were not incorporated within the box, the belief that the complete receiver, including all accessories, could be made even smaller prompted me to undertake the mechanical redesign of his miniature portable.

As will be seen from the photograph, the complete receiver that I built fits into the palm of the hand and requires only that it be held near the ear to enjoy a broadcast program.

The complete receiver was assembled on a 2 3/4 x 4 inch panel, with all parts and the A securely mounted to the panel to permit ease of wiring and future removal from the case for battery replacement. The case measures 2 inches deep and houses the B

battery. The A battery is fastened by a clamp to the back of the panel.

The microtubes have no bases and pins as do larger tubes, and therefore have their leads connected to the necessary terminals. Two of these tubes (one M74 and M54 audio tubes) are held in place by the wiring. To prevent possible breakage of terminals or shorting of terminals, I used two strips of celluloid, one on each side of the tube wires, cementing them together with acetone into one solid piece. The soldered joints were made below the point where the wires project.

The detector stage required shielding. This was done by wrapping a piece of thin sheet copper around the M74 detector tube to a fairly tight fit, sliding the shield away from the tube and soldering it to form a cylinder, leaving a small amount of copper extending beyond the joint to be able to solder a connection for the ground. This tube was placed adjacent to the trimmer condenser, which in this case serves as the tuning condenser.

The wiring presented no great difficulty, the only necessary precaution having been to keep the terminals relatively short. This meant that most of the condenser and resistor leads had to be shortened.

I found that by changing the coil from the one used by Mr. Dezettel, I could obtain greater selectivity. I made up a tube by rolling up some gummed paper tape into a half-inch coil form, that is, one-half inch in diameter and one-half inch long. About 75 turns of No. 32 enameled wire make a good primary. The secondary consists of 25 turns of the same size wire. The experimenter should make up several coils, varying the number of turns, and select the one best suited for radio reception in his locality. The turns can be random wound, but a space of at least 1/8 inch

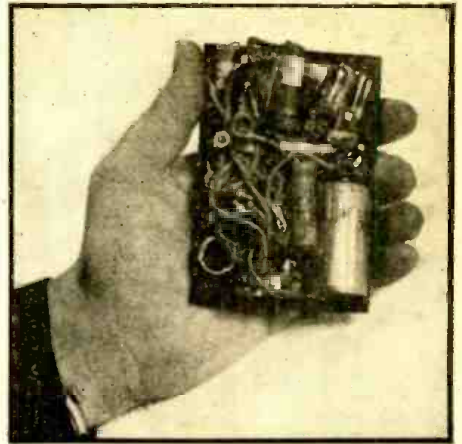

should be left between primary and secondary windings.

For aerial and ground terminals I used pin jacks to avoid having bulky binding posts on the panel. It was necessary to cut down the excess insulated portion of the two-pin-jack assembly a bit to make it fit between the A battery and the antenna coil.

The feature which I believe to be the most novel is the improvised loudspeaker. This was made from a single Trimm earphone. I removed the cap and made a correspondingly sized washer, 1/16 inch in thickness, out of celluloid and placed it between the earphone and the back of the panel. This permits free movement of the diaphragm, while holding its outer periphery securely to the panel. A number of holes drilled in the panel exposed a sufficient amount of the diaphragm disc so as not seriously to impede the sound.

The on-and-off switch is a miniature rotary which I happened to pick up somewhere. Only a locking nut and two wires protrude in back of the panel.

The tuning condenser is a small Meissner trimmer which varies in capacity from 125 to 350 mmf. This trimmer has a ceramic casing and has the usual slotted screw projecting from the top. Although originally I placed the trimmer behind the panel, I found that this caused too much cramping of the parts and therefore I mounted the whole trimmer on the front of the panel,

(Continued on page 55)

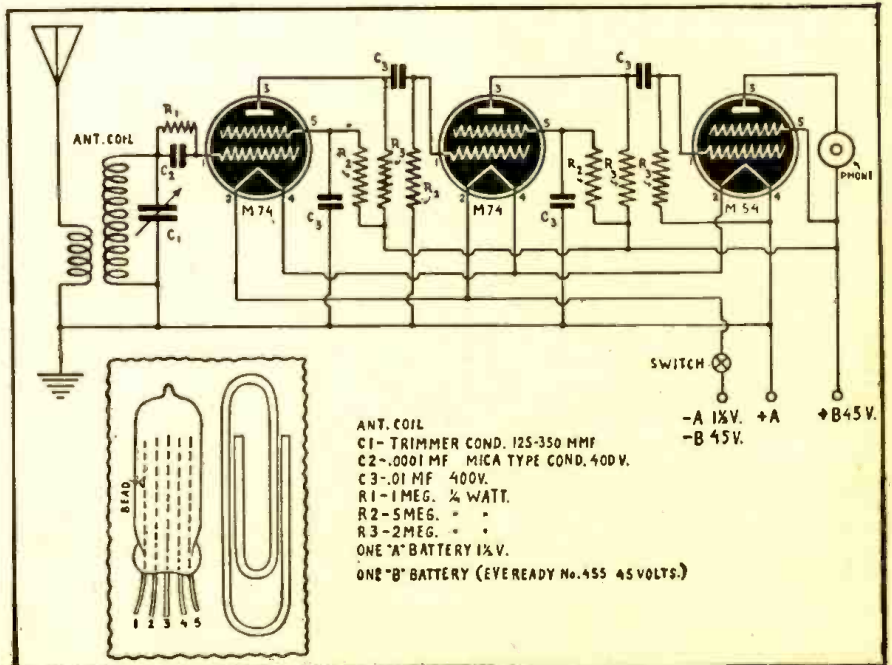

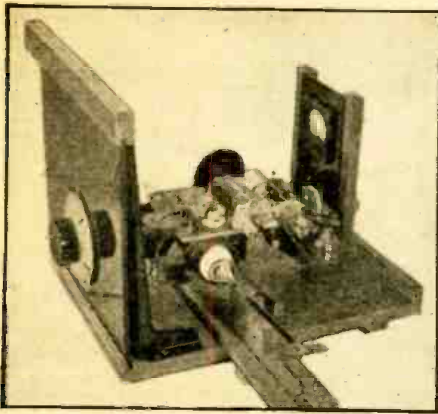

EGG-FERTILITY RADIO TESTER

High-frequency oscillator and resonant tank.

A METHOD of measuring conductivity and dielectric effects without the use of electrodes in contact with the material being measured has been developed at Cornell University Agricultural Experiment Station, Ithaca, New York.

Utilizing a high-frequency oscillator and a resonant tank circuit Dr. Alexis L. Romanoff and Karl Frank, of the Department of Poultry Husbandry, have been able to apply this method in their studies of detection of fertility of fresh eggs.

Observations previously made by Dr. Romanoff and an associate, using an audio-frequency bridge, showed that the electrical conductivity of yolk and albumen of fertile eggs increased from the beginning of incubation. This suggested the possibility of observations on the whole egg showing differences between fertile and infertile eggs if a radio-frequency circuit were used and effects due to eddy current losses observed.

The test apparatus is shown in Fig. 1. A radio-frequency circuit consisting of a variable condenser, inductance coil and thermoammeter was driven by a link-coupled stable 5-watt generator at frequencies ranging from 14 to 14.4 megacycles. The method followed was to ob-

serve the effects on maximum current and resonant frequency in the radio circuit by introducing an egg into the coil. These effects depend upon the conductivity of the egg which reduces the current, and upon its dielectric constant which by increasing the coil capacity lowers the resonant frequency.

These studies indicated that at these frequencies the conductivity was lower and the dielectric effect higher in fresh fertile hens' eggs than in infertile. In view of these results the Cornell experimenters decided to extend the study of the intact egg to a wider range of frequencies.

To cover the range between 2 and 60 megacycles two separate oscillators were used. The source for the lower frequency range of from 2 to 15 megacycles was the oscillator shown in Fig. 1. For the 15 to 60 megacycle range a special oscillator (Fig. 2) was constructed. The power supplies for both oscillators were fed from a 60-watt voltage regulator and there was negligible frequency drift or detuning on loading.

Figure 2 shows the circuits of power supply, high-frequency oscillator and resonant tank. The 450-volt power supply feeds a tuned-plate tuned-grid type oscillator using two 210-Ts in push-pull mounted base to base, which in turn drives the resonant tank

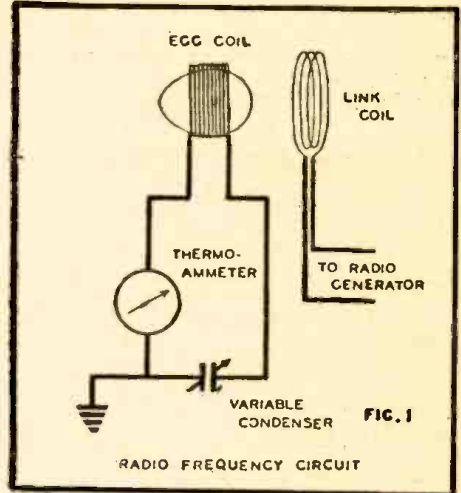

with egg coil or dielectric cell.

The oscillators were coupled inductively to the resonant tank circuit which was connected in parallel with a pair of circular plates forming the dielectric cell. The 3 to 15µmf variable tank condenser was provided with a very accurate micrometer

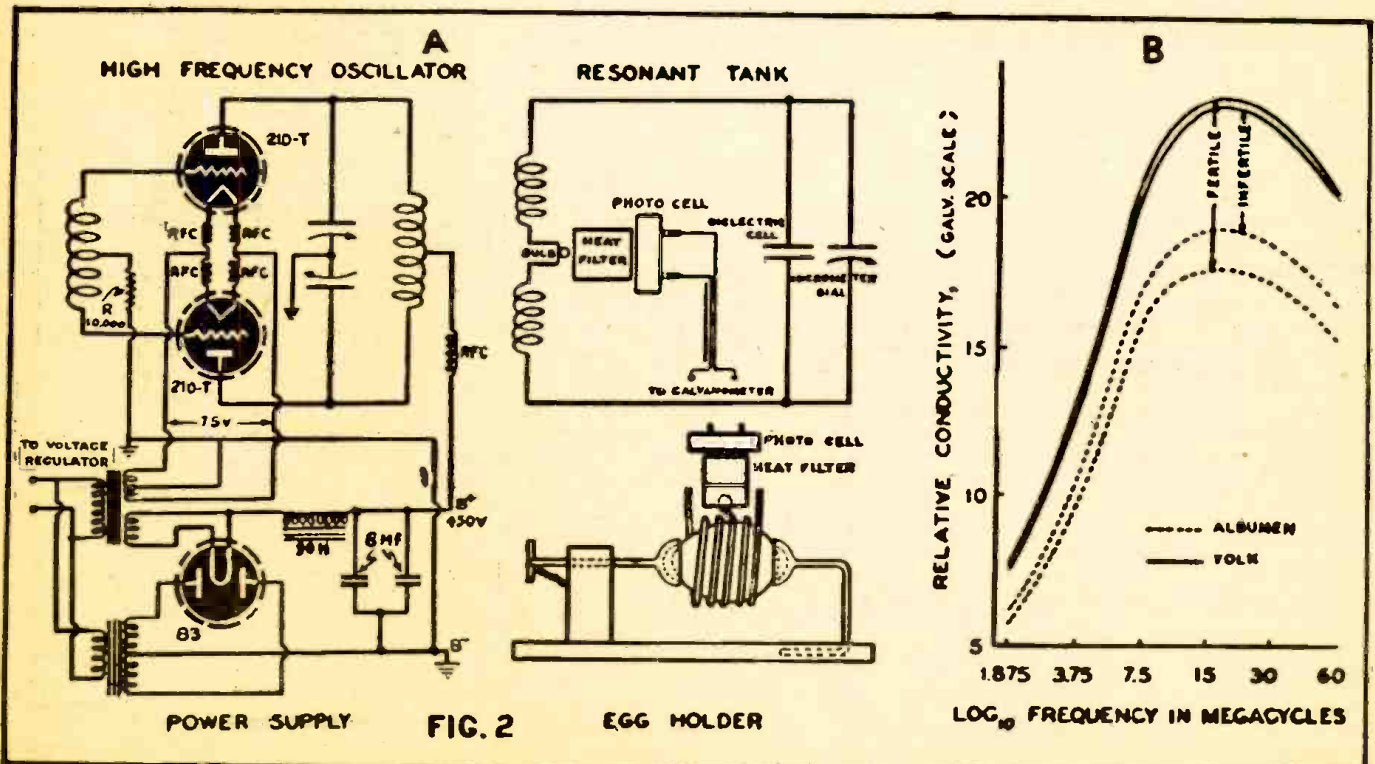

FIG. 2

worm drive and dial permitting settings of the condenser capacity to an accuracy of $\pm 0.002\mu\text{f}$. In the center of the tank coil was mounted a small 2.3-volt flashlight bulb above which was a photronic cell protected by a copper sulphate heat filter. A galvanometer shunted to critical damping registered the intensity of the light from the bulb.

The entire apparatus was placed in a shielded cage and operated by remote control. The power output from the oscillators showed a long period drift of less than 1 cm galvanometer scale reading per hour for the ultra-high frequency oscillator and somewhat more for the lower frequency oscillator.

When measurements on whole eggs were being made the egg was mounted inside the resonant tank coil by means of an egg-holder sliding on a track and consisting of two opposing glass cups pulled together by

electric effects on several lots of intact eggs at frequencies of 54.6 and 27.3 megacycles showed tendencies in relative values of fertile and infertile eggs very similar to those previously observed at lower frequencies. There was greater separation in conductivity in favor of infertile eggs. The dielectric effect was less consistent, although again showing higher values for fertile than for infertile eggs.

The measurements of the conductivity and dielectric effect of the egg components yolk and albumen were then made to locate the region where the principal differences between fertile and infertile eggs occur. Curves on relative conductivity (Fig. 2-B) shows that the values for various parts of the egg were maximum at about 15 megacycles. The difference in power absorption of any sample between high and low frequencies was large, but the percentage difference between 2 different samples remained almost constant over the en-

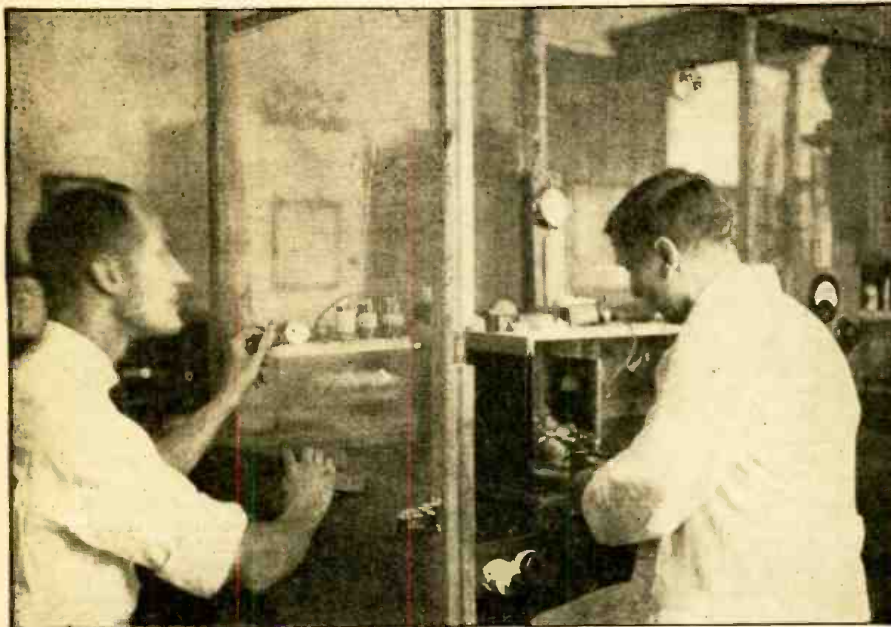

Dr. Alexis L. Romanoff, right, and Karl Frank, of Cornell University Agricultural Experiment Station, Ithaca, N. Y., shown at the high-frequency conductivity testing apparatus.

a spring. The long axis of the egg was thus automatically made to coincide with the principal axis of the coil. By this method the effect of position of the egg was reduced to a minimum and readings on an individual egg could be repeated very precisely. The coupling between the oscillator and the resonant tank was standardized by means of a glass egg filled with egg albumen.

The readings on yolk and middle dense albumen were made alternately on fertile and infertile individual eggs. Outer and middle fluid layers of albumen, owing to the small amounts available, from each egg, were studied from composite samples only. Measurements of conductivity and di-

electric effects on several lots of intact eggs at frequencies of 54.6 and 27.3 megacycles showed tendencies in relative values of fertile and infertile eggs very similar to those previously observed at lower frequencies. There was greater separation in conductivity in favor of infertile eggs. The dielectric effect was less consistent, although again showing higher values for fertile than for infertile eggs.

The relative conductivity and dielectric effect of the intact egg at frequencies of 27.3 and 54.6 megacycles gave results indicating that fresh infertile eggs have a higher conductivity and a tendency towards lower dielectric constant than fertile eggs.

The conductivity values for various parts of the egg were maximum at about 15 megacycles. There was no frequency dependence for the percentage separation between yolk and albumen over the range from 2 to 60 megacycles.

RADIO DIRECTION FINDERS

(Continued from page 35)

calibration. For example, a guard rail torn down by a storm may throw the loop "off," or a correction factor must be applied to take into account the presence of metal objects in the field of the loop. In the case of a plane, a similar deviation is to be expected and it is necessary to calibrate the

loop once it has been installed.

One way of doing this is to fly the plane a distance of about 50 miles from a station whose location is definitely known. The directional gyro can then be set for a straight course and the loop adjusted for calibration or a calibration disc made up. If a gyro is not at hand, a straight road can be used, the plane flying above the straight road.

SPRAYBERRY RADIO TRAINING

includes
FULL EQUIPMENT

Experience Easily Acquired
at Home



You Do Practice-Giving Experiments. Many Special Features... ALL Designed to Help You Make Fast Progress

SPRAYBERRY Training starts right at the beginning of Radio. You easily learn Television, Frequency Modulation, Signal Training, Mobile Radio (Auto-Tank), Aviation Radio, Electronics, Facsimile Radio, Radio Set Repair and Installation work.

Training Prepares You for a Business of Your Own... or Good Radio Jobs—Civilian or Military

Today, Radio offers remarkable opportunities to the man who wishes to get ahead. My Training will help you win quick promotion in the Army or Navy... will fit you for a bright Civilian career. Your Training will not interfere with your present duties. No previous experience is needed.

You Get a Dual-Purpose Radio Set

I supply you with Radio Parts which you use to gain pre-experience in Repair work. These same Parts are used as a Modern Signal Generator and for Signal Training, etc. You'll find my Course and Equipment fully described in the catalog offered below. But in addition to this catalog, I am going to send you a valuable new manual.

YOUR'S FREE! Just Off The Press!

Big 80-Page Book "RADIO SERVICE SHORT CUTS"

Don't miss it! It's a rich storehouse of practical tips and information. Tells how Radio break-downs occur... how to correct them quickly and efficiently. If you ACT now, you can get this book FREE... along with my descriptive Course Catalog. Use coupon below!

THE SPRAYBERRY COURSE IS SOLD UNDER MONEY-BACK AGREEMENT

RUSH COUPON for BOTH FREE BOOKS

SPRAYBERRY ACADEMY OF RADIO
 F. L. Sprayberry, President
 520-K University Place, N. W.
 Washington, D. C.

Please run my FREE copies of "HOW TO MAKE MONEY IN RADIO" and valuable 80-page "RADIO SERVICE SHORT CUTS."

Name _____
 Address _____ State _____
 City _____ (Mail in envelope or paste on penny postcard)

BIG BOY

MODEL 860



Performance... Eye Appeal... Value... Sensationally Priced at \$19.65. Dealer Not Price.

Here is an AC-DC Volt-Ohm-Milliammeter with all the ranges you want... easily readable on the large 7" instrument with extra-long 6" scale, in a new up-to-the-minute three-tone case. DC Volts 0-10-50-250-500-1000 at 5000 Ohms per volt DC; 1000 ohms per volt AC. AC Volts 0-10-50-250-1000 at 400 ohms per volt; DC Ma. 0-1-10-100; Resistance ranges: 0-1500 Low Ohms; 0-150,000 Ohms and 0-7.5 and 0-15 Megohms. Maroon case with red and silver panel, attached handle.

Dealer Net Price, \$19.65

For Catalog Write—Section 1117, College Drive

READRITE METER WORKS, Bluffton, Ohio

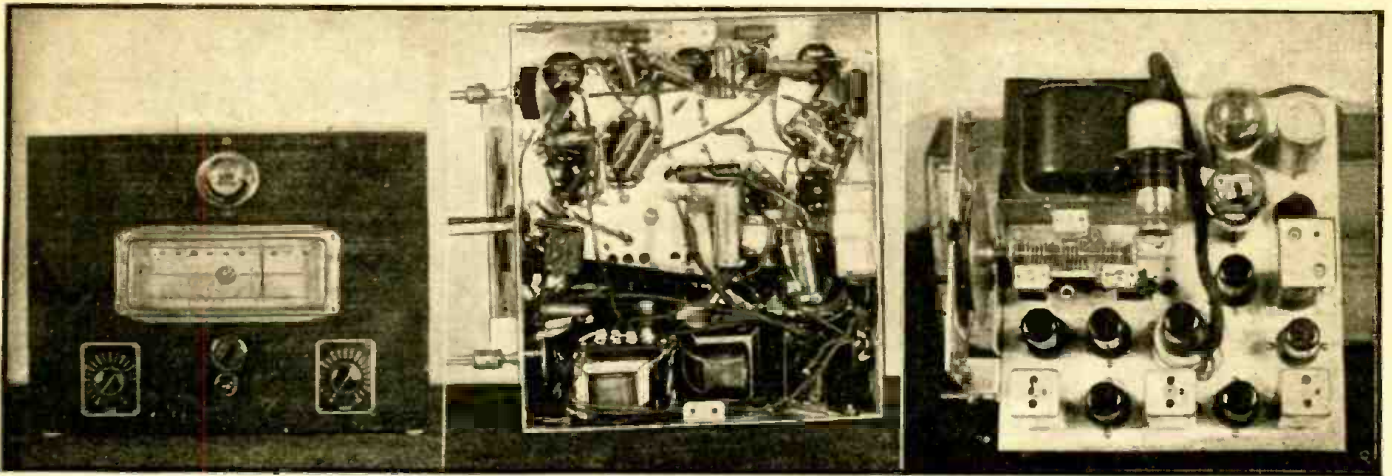

11 - Tube Frequency Modulation Receiver

By GEORGE FRANCIS BAPTISTE

FREQUENCY-MODULATION sets no longer are manufactured for consumer sale, and except for some dealer stocks that may be gone by the time you inquire about them, there are none to be had. The experimenter who has some suitable parts on hand and is willing and able to purchase what he needs to fill in the gaps in his equipment need not be discouraged. The receiver built by the writer may be duplicated by the experimenter by using the parts listed in the article, or he can make necessary substitutions if he keeps sufficiently close to the constructional plan outlined here.

The schematic diagrams illustrate the general wiring plan of the 11-tube F-M receiver. One preselector stage of radio-frequency, utilizing a type 1852/6AC7 television-type R.F. pentode for high-gain amplification, feeds the signal to a 6SA7 combined first detector and oscillator, which oscillator tube was found to have a low frequency drift. This is followed by three I.F. stages the first two using single-ended 1852 pentode tubes, which also have low frequency drift, and the third stage, called a limiter, using a 6SJ7.

The second detector is a type 6H6 tube.

A 6SC7 is used as an amplifier to operate a type of 6AD6 dual tuning indicator, which tube offers the advantage that the F-M receiver can be tuned to the center frequency (mid-frequency) by noting the indications of the tuning-ray shadow angle. A 6SF5 is used as the first audio stage (see Fig. 2) and this is followed by a 6F6G output pentode. A type 80 rectifier furnishes ample current for the power-supply requirements. Dual speakers or a single speaker can be connected to the output transformer, since it is of the universal type.

The complete frequency-modulation receiver is mounted on a Browning chassis (see part list), the speaker or speakers being placed in a cabinet to suit one's own taste and pocketbook. The size of the F-M receiver in the cabinet is 12 inches wide by 9 inches high by 12 inches deep. The F-M range is from 40 to 50 mcs.

CONSTRUCTION

The construction of this receiver should not be difficult if a few precautionary measures consistent with good wiring practice are observed. The Browning chassis must have a few holes added to permit

mounting the type-6SC7 tuning-indicator amplifier tube. An Amphenol above-chassis socket is preferable here because the side holes simplify the problem of carrying wiring from below the chassis to the tuning indicator, which is well above the chassis level.

Figure 3 and the photograph should be consulted for the placement of these tubes as well as for the layout of the various tube sockets and I.F. transformers, power supply, etc. The installation of the power transformer used requires that its chassis hole be made larger. This transformer is of the half-shell type and has a rating of at least 125 milliamperes. Keep the power transformer as close to the corner of the chassis as possible. You can construct your own F-M tuner, amplifier and power supply as separate but interconnected units, depending upon available materials rather than on strict adherence to the plan described.

If a Browning tuning unit (described by the author in the Jan.-Feb. issue of *Radio-Craft*, p. 382) is not available, suitable parts may be obtained from Wholesale Radio Service Company. The parts list at the end of this article gives the part numbers. The Lafayette F-M tuning condenser

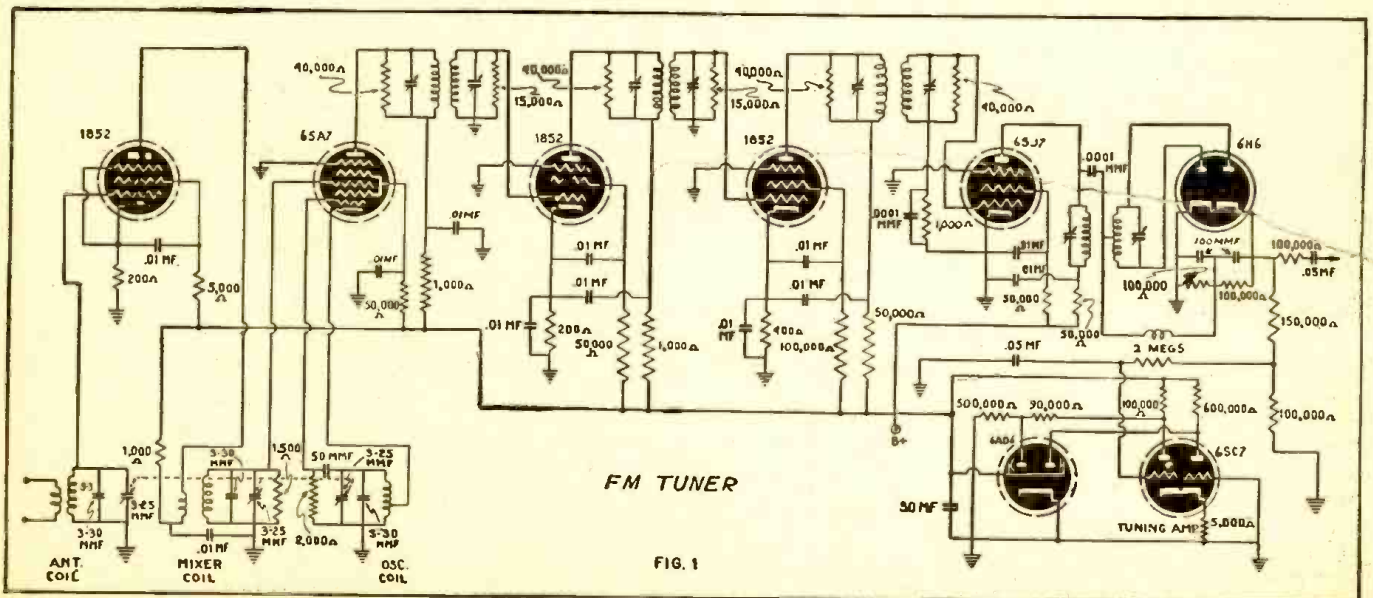

is 2½ inches long by 15/16 high by 1¾ wide. The antenna coil, R.F. coils and mixer coil are one inch long. The antenna and oscillator coils are mounted to the right and on the side of the tuning condensers above the chassis and the radio-frequency coil on the left side of the gang condenser or underneath it, at right angles. Leads from the various coils are taken through the chassis to the tubes socket connections. Be sure to keep all grid and plate leads as far apart as possible. Wire all tube heater connections first, then wire in the power supply and bleeder system, leaving the B supply connections to the various points for the last operation.

CONSTRUCTION

The power supply (Fig. 2B) is standard and requires no explanation. The audio system (Fig. 2A) can be varied to suit one's own requirements. A separate high-fidelity amplifying may seem desirable but was found unnecessary, judging from the excellent results obtained with this audio system.

The choke and universal output transformer are mounted under the chassis in the rear near the dual 8mf filter condenser, ample room being provided for the transformers given in the parts list.

The photographs show a front view of the complete F-M receiver, a general view of the top chassis and a bottom view of the same chassis, parts and wiring. The I.F. transformers and tube socket should be mounted with their terminals and connections in such positions that all plate and grid leads are as direct and as short as possible. Bypass condensers should be mounted on their ends, as this gives a shielding effect, and they should be placed between grid and plate, adding to the shield of the plates and grids, at the same time making all leads as short as possible. Rigid wire should be used wherever possible. The circuit diagram looks similar to the usual superheterodyne, except that all the I.F. transformers have resistors placed across them to damp out transient oscillations which otherwise would cause fuzzy frequencies in the output. These resistors also widen the band pass of the I.F. transformers, and in this case, where the I.F. is 3 megacycles, the band width is approximately 150 kc. Such an I.F. system is made broad instead of selective as in the regular I.F. stages in amplitude modulation systems. The limiter or third stage of I.F. uses a 6SJ7 tube, which has a sharp cut-off, no bias being employed on this tube so that it can operate at the point of saturation. The detection transformer is similar to the type used in so-called discriminator in automatic frequency-controlled circuits, but its function is quite different, this transformer being designed so that when the signal frequency is varied at an audio rate the audio voltages are developed in the diode sections of the 6H6 tube, which voltages are fed to the audio amplifier system. The network of condensers and resistors used in this tube circuit are necessary because frequency modulation stations pre-emphasize the high frequencies—this is standard practice—to obtain a flat audio-frequency response at the loud speaker of the receiver, and it is necessary to compensate for this and "deemphasize" in the receiver.

ALIGNMENT DATA

When the F-M receiver has been completely wired and carefully checked proceed as follows for correct alignment: Disconnect the grid wire from the 6SA7 tube and feed a signal from a signal generator

into the grid (this must be a three megacycle signal); then adjust each I.F. transformer for maximum gain, adjusting the third I.F. transformer first. Maximum gain will be indicated by the dual tuning-indicator shadow angle, which will narrow more as each stage is tracked properly at its correct resonance frequency. In the alignment process the tuning indicator may overlap considerably and if such is the case all that is necessary is to reduce the signal generator output and recheck. With a signal of about one millivolt from the signal generator the tuning indicator should completely close. The final step is to adjust the detection transformer. Do not change the setting of the signal generator, but use a high-sensitivity voltmeter of 5,000 ohms per volt or better. If the meter is of the center-zero type so much the better; connect this between cathode number four of the 6H6 tube and the ground (chassis) and proceed to align the transformer with the three-megacycle signal feeding into the grid of the 6SA7 tube. Adjust the secondary trimmer of the detection transformer (this will be the trimmer nearest the 6H6 tube) until zero voltage is obtained, as indicated on the voltmeter. Now change the signal generator frequency to 2.90 and 3.10 mc. alternately and adjust the primary trimmer so that equal and opposite voltages are developed. Next readjust the signal generator to three megacycles and check to see if zero voltage is obtained at three megacycles. If it is not obtained, readjust the secondary trimmer slightly to obtain the zero voltage. When this result is obtained the complete I.F. System is properly aligned. Be sure that your alignment tool has no metal in it, as this will detune the circuit due to the capacitance being introduced into the circuit. With this operation complete disconnect the signal generator from the 6SA7 tube grid and reconnect the grid wire back to the grid of the 6SA7 tube, making sure that it is soldered properly.

The next step is to align the R.F., detector and oscillator stages. You can feed a 45-megacycle signal into the antenna system or use an F-M station that is around this frequency. First adjust the antenna trimmer, then the detector trimmer and finally the oscillator trimmer. This process may have to be repeated to have the dial pointer track properly. Sometimes a slight readjustment of the antenna trimmer will bring signal more into the resonance frequency. This can finally be checked by observing the dual tuning tube for equal shadow angles in a horizontal position. It may be well to state that these stages tune rather broadly, but this is perfectly right for the damped circuits.

The speakers used with this receiver were a Jensen high-frequency tweeter five-inch P.M. and one Jensen twelve-inch low-frequency P.M. woofer. Both speakers had eight-ohm voice coils, and as connected in parallel, present an impedance load to the transformer winding of four ohms. Any other combination, such as two four-ohm voice coils will give a load impedance of two ohms, etc. Other combinations were tried and all worked out successfully, with ample audio power to spare.

In tuning the receiver, be sure to tune for a horizontal pattern with equal shadow angles on both sides of the 6AD6 tuning-indicator tube. As a final note, there are three points on the dial where you can tune your F-M station; the center one is the correct one and this can be noticed by observing the tuning indicator-tube shadow angles. On either side you will not be able to equalize the shadow angles and this shows that it is off tune. When they are equal it is properly tuned.

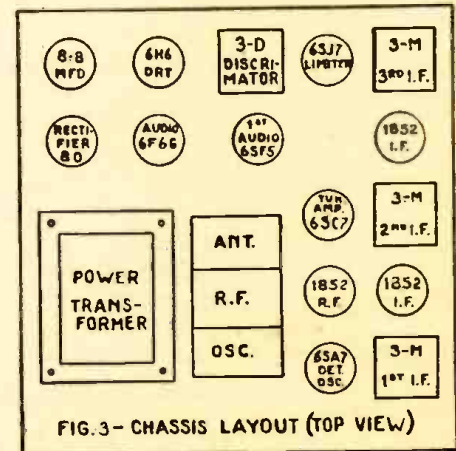
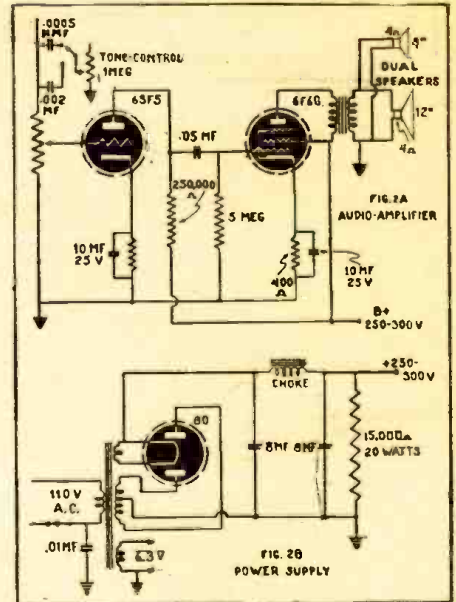

Frequency Modulation Parts List
RESISTORS ½-WATT VALUE, IRC

- Two 200 ohm
- Two 400 ohm
- Four 1000 ohm
- One 5000 ohm
- One 10,000 ohm
- Five 50,000 ohm
- Three 15,000 ohm
- Four 40,000 ohm
- One 20,000 ohm
- One 90,000 ohm
- Six 100,000 ohm
- One 2500 ohm
- Two 250,000 ohm
- Two 500,000 ohm
- One 600,000 ohm
- One 2 megohm
- One .5 megohm volume control with switch
- One 1 megohm tone control
- One 15,000-ohm 20-watt resistor for bleeder

CONDENSERS—AEROVOX 600-VOLT TYPE

- Fourteen .01 mf.
- Three .05 mf.
- Three 100 mmf. mica
- One 50 mmf. mica
- One 1000 mmf. mica
- One 30 mf. 450 volts
- One 8-8 mf. dual electrolytic condenser, 450 volts, 550 peak volts
- One .002 mf. mica
- One .0005 mf. mica
- Two 10 mf., 50 volts, electrolytic

BROWNING LAB. PARTS

- One 3D I.F. transformer
- Three 3M I.F. transformer
- One 100C chassis
- One 6D slide rule tuning dial

TRANSFORMER THORDARSON

- One T-13S42 Universal output transformer

TRANSFORMER PHILCO

- Power transformer part No. 32-7440 flush mounting, 123 ma.
- One filter choke, part No. 32-7115, 125 ma. or similar 20 henry choke

(Continued on page 64)

FOR VICTORY TODAY AND SOUND BUSINESS TOMORROW

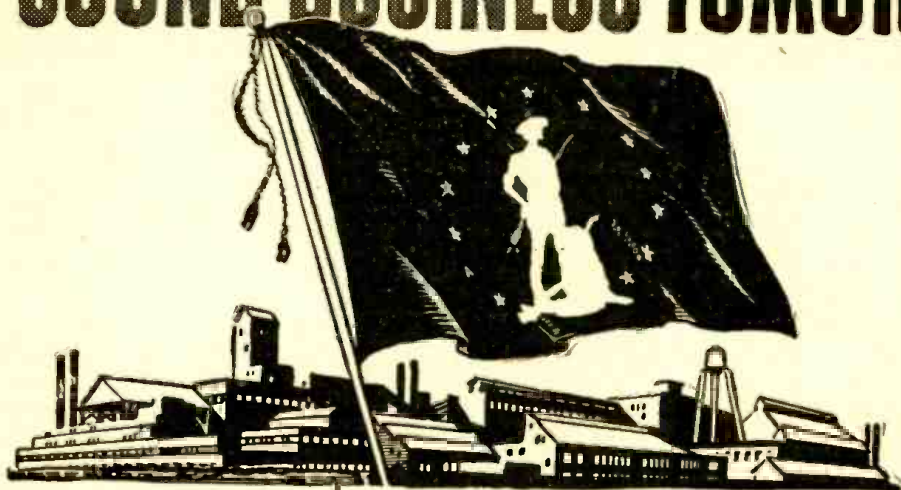

Get This Flag Flying Now!

This War Savings Flag which flies today over companies, large and small, all across the land means *business*. It means, first, that 10% of the company's gross pay roll is being invested in War Bonds by the workers voluntarily.

It also means that the employees of all these companies are doing their part for Victory . . . by helping to buy the guns, tanks, and planes that America and her allies *must* have to win.

It means that billions of dollars are being diverted from "bidding" for the constantly shrinking stock of goods available, thus putting a brake on inflation. And it means that billions of dollars will be held in readiness for post-war readjustment.

Think what 10% of the national income, saved in War Bonds now, month after month, can buy when the war ends!

For Victory today . . . and prosperity *tomorrow*, keep the War Bond Pay-roll Savings Plan rolling in *your* firm. Get that flag flying now! Your State War Savings Staff Administrator will gladly explain how you may do so.

If your firm has not already installed the Pay-roll Savings Plan, *now is the time to do so*. For full details, plus samples of result-getting literature and promotional helps, write or wire: War Savings Staff, Section F, Treasury Department, 709 Twelfth Street NW., Washington, D. C.



Save With

War Savings Bonds

This Space Is a Contribution to America's All-Out War Program by

RADIO—CRAFT

The "Nerve Center of the Army" needs your skilled hands TODAY!

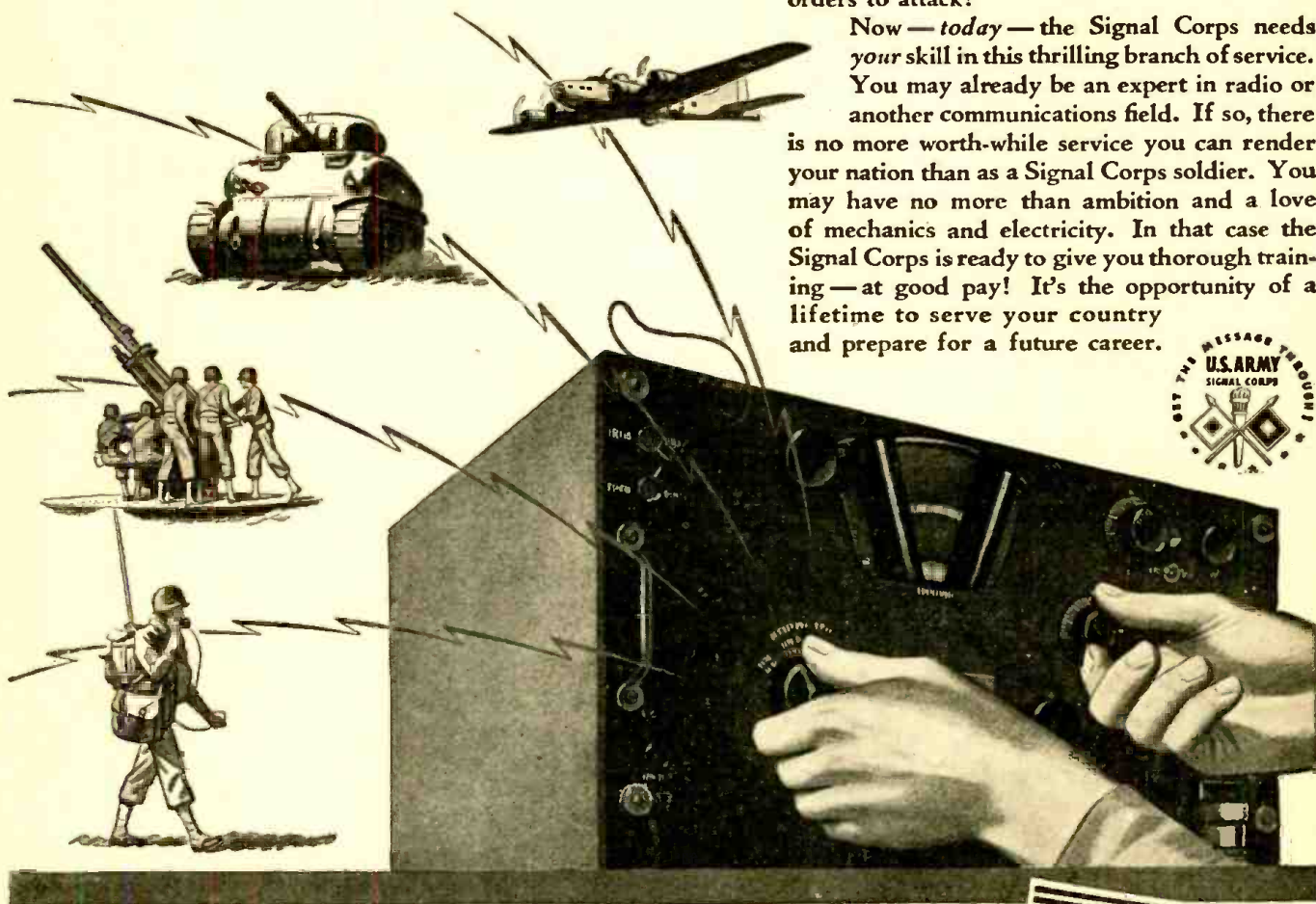

THIS is a war of speed—a radio war. Commands and messages must go through like lightning. Never have communications been so vital to victory, or have new devices meant so much.

The whole responsibility for "getting the message through" is in the hands of the U. S. Army Signal Corps. Hands that install and maintain countless thousands of radio sending and receiving sets—hands that adjust the marvelous mechanisms of America's newest and most secret weapons—hands that flash the orders to attack!

Now—*today*—the Signal Corps needs your skill in this thrilling branch of service. You may already be an expert in radio or another communications field. If so, there is no more worth-while service you can render your nation than as a Signal Corps soldier. You may have no more than ambition and a love of mechanics and electricity. In that case the Signal Corps is ready to give you thorough training—at good pay! It's the opportunity of a lifetime to serve your country and prepare for a future career.



HOW YOU CAN GET IN NOW

1. ENLISTMENT

If you are 18 to 45 and physically fit, you may apply for enlistment in the Signal Corps or in the Signal Corps Enlisted Reserve.

DIRECT ENLISTMENT: Experience as a licensed radio operator, a trained radio repairman, a telephone or telegraph worker, will qualify you for active duty at once. From Private's pay you can advance rapidly as you earn higher technical ratings—up to \$138 a month, with board, shelter and uniforms.

ENLISTED RESERVE: If you are skilled with tools but lack qualifying experience, you may enter the Enlisted Reserve. You will be given training, with pay, in one of the many Signal Corps schools, and ordered to active duty when you have completed the course.

COMMISSIONS: Graduate Electrical Engineers may apply for immediate commissions in the Signal Corps. And special opportunities for training and commissions are open to Juniors and Seniors in electrical engineering colleges.

2. CIVILIAN TRAINING

If you are over 16 years of age, and even though registered for Selective Service, have not received your order to report for induction, the Signal Corps offers you an outstanding opportunity.

If you have ability with tools—if you want to secure training in the vitally important field of communications—you may attend a school in or near your home city. You will be paid not less than \$1020 per year *while learning*. And when you have finished your training—in 9 months or less—you can advance to higher pay as your technical skill increases.

Even if you have a minor physical handicap, Signal Corps Civilian Training may give you the chance you've wanted to serve the Army of the United States.

"KEEP'EM FLYING!"

U. S. Army

FOR FURTHER INFORMATION REGARDING ENLISTMENT—Call and talk this over at the nearest Army Recruiting and Induction Station. Or write to: "The Commanding General," of the Service Command nearest you:

First Service Command	Boston, Massachusetts
Second Service Command	Governors Island, New York
Third Service Command	Baltimore, Maryland
Fourth Service Command	Atlanta, Georgia
Fifth Service Command	Fort Hayes, Columbus, Ohio
Sixth Service Command	Chicago, Illinois
Seventh Service Command	Omaha, Nebraska
Eighth Service Command	Fort Sam Houston, Texas
Ninth Service Command	Fort Douglas, Utah

Or write to: Enlisted Branch, AK-1, A.G.O., Washington, D. C.

FOR CIVILIAN TRAINING INFORMATION—Call at any office of the U. S. Civil Service or U. S. Employment Bureau.

GETTING STARTED IN RADIO

By C. W. PALMER

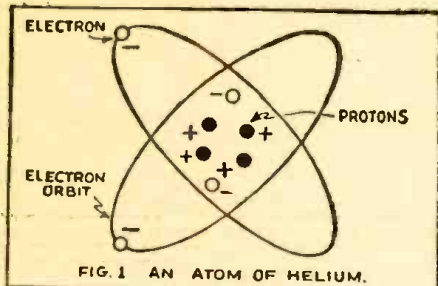

FIG. 1 AN ATOM OF HELIUM.

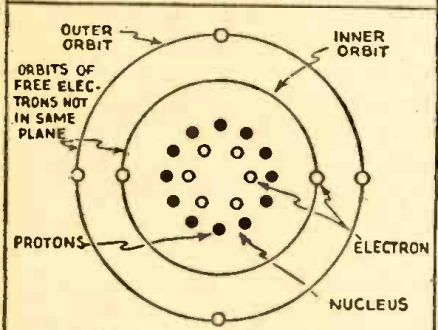

FIG. 2 AN ATOM OF CARBON.

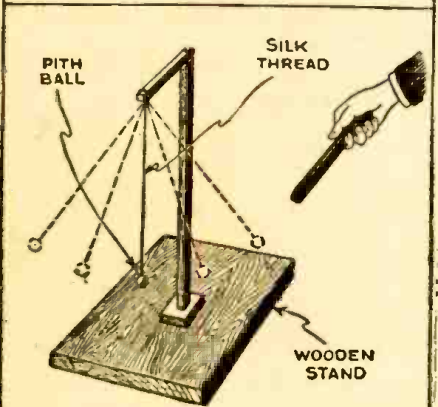

FIG. 3 A STATIC EXPERIMENT.

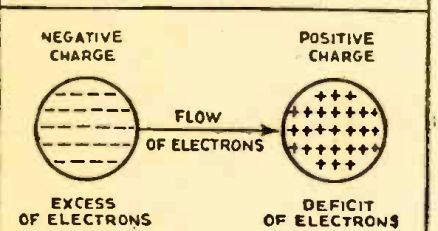

FIG. 4 TRANSFER OF SURPLUS ELECTRONS.

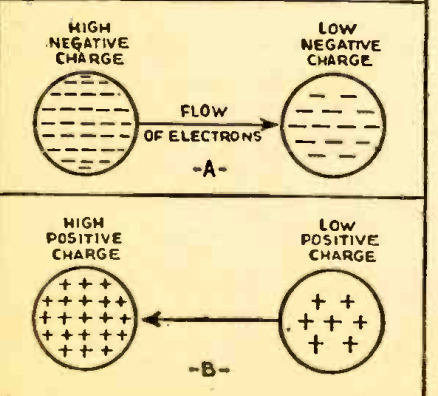

FIG. 5 EXAMPLES OF ELECTRON FLOW.

FOR the benefit of those who have a very limited knowledge of radio, we will assume that the reader is entirely unfamiliar with the subject. Therefore, we beg those more fortunate readers with some past experience to be patient if we spend undue time in explaining every technical word and expression.

To understand how radio signals are received, it is necessary to have a knowledge of electricity—the basis of radio. Suppose, then, we start by considering the subject from the very beginning.

ELECTRONS

Matter is any substance having weight and volume. The air we breathe, the water we drink and the earth on which we live are all forms of matter. Matter of all kinds is composed of tiny specks which have been called *atoms*. These atoms, in turn, are made up of a number of still smaller particles of two kinds, and in order to start out with the right foot, we will give these particles their correct names—*electrons* and *protons*. The electrons are tiny charges of negative electricity, and the protons are charges of positive electricity. Do not make the mistake made by some people when thinking about electrons and protons. They do not carry the electricity, they are the electric charges. If a negative charge of electricity were divided into many small charges, eventually a minute charge would be reached that could no longer be divided. This final division would be an electron. So much for the electron and proton.

Normally, each atom contains a definite number of electrons and protons, in such a combination that the charges just equal each other. The atom is then said to be uncharged or neutral. Figures 1 and 2 show examples or normal atoms. However, if a force is applied to the atom, some of the electrons will be pulled away from it and it will have an excess of positive electricity compared to the remaining negative charges. Conversely, if a force is applied in the opposite manner, too many electrons are present in the atom and it is said to have a negative charge.

We can perform an interesting experiment at this time, to illustrate the effect of charging a body. For this experiment we need a rod of hard rubber (some fountain pens are made of this material), a glass rod, a piece of silk cloth and a small piece of pith from a corn cob. We suspend the pith on a silk thread, as shown in Fig. 3. Then we rub the glass rod vigorously with the silk cloth and bring it near the pith ball. It will be found that the pith ball will follow the glass rod—it is attracted by it. Then we allow the rod to touch the pith ball and notice that it now repels it. Now rub the rubber rod and bring it near the pith ball—it attracts it.

The glass rod receives a positive charge when rubbed and the rubber rod receives a negative charge. This is the reason why we notice the difference in their actions on the pith ball. From this experiment, we

learn that two like charges repel (the pith ball and the glass rod were both positive when they were allowed to touch) and unlike charges attract (the positively charged pith ball was attracted by the negative rubber rod).

CONDUCTORS AND NON-CONDUCTORS

Some materials, such as gold, copper, silver, brass, aluminum, etc., present very little opposition to the passage of electric currents. Others, such as cotton, silk, rubber, wood, mica, etc., will not readily pass a current. The first class of substances is called *conductors*. The atoms of most metals apparently do not have a very strong hold on the electrons which make up their negative charge. An external force can easily remove some electrons or add some to the normal number. The second class of substances mentioned is known as *non-conductors*. They have a strong hold on the electrons and will not readily change from their neutral state.

POTENTIAL

We have learned that like charges repel each other and unlike charges have an attraction for each other. If we translate this into terms of electrons, it will read: electrons repel each other but attract protons, and similarly, protons repel each other but attract electrons. Apparently the feeling of the protons and electrons is mutual.

If we charge a body with negative electricity (add electrons) a stress or strained condition is set up in that body by the electrons repelling each other. Some of these "free" electrons move to the surface of the body to get away from the others. The more electrons we put into the body, the greater becomes the force of the electrons trying to escape. This force which tends to return a body to neutral is called a "potential." The same effect is noticed in a body from which electrons are removed.

To illustrate the effect described, suppose we refer to Fig. 4. The two balls shown are charged, one negatively and the other positively. If we touch these balls together, the excess electrons in the negative one will rush to the positive one. It follows directly from this that a current will flow, as we already explained that electrons are electric charges. Several other examples of current flow are shown in Fig. 5. At A, the left copper ball has a higher negative charge than the right one, causing a current to flow from left to right. At B, the left copper ball has a higher positive charge than the right one and a current will flow right to left—the right ball has more electrons than the left one.

It will be noticed that the electrons move from negative to positive and since we know that electrons are electricity, it follows that the current is also from negative to positive: A number of years ago, before we knew as much about electricity as we do now, physicists experimenting with it decided that the current flowed from positive to negative and this illusion has been passed

down to the present time and is still commonly used. We must keep this discrepancy in mind as it is important in understanding the operation of vacuum tubes and other electric devices.

The difference in potential, as that shown in Figs. 4 and 5, is measured in *volts*. Because a difference in potential always causes a current to flow, we sometimes call it an electro-motive force (E.M.F.). Current strength, that is, the number of electrons passing through an electric conductor per second, is measured in *amperes*.

RESISTANCE

We have found that the current flowing through an electric circuit is dependent on the potential. We also learned that some materials will carry a current (lose and gain electrons) more easily than others. The opposition that a conductor offers to the passage of a current is known as resistance. The resistance depends on the kind of material, the length of the conductor and the cross-sectional area. To be exact, the resistance increases directly as the length of the conductor. A standard unit of resistance has been set up and is called the *ohm*, in honor of the noted German physicist, George Simon Ohm.

If we analyze the above information, we learn that the current depends on the volts and also on the resistance. In 1827, George Simon Ohm put this relationship into terms of arithmetic and it is known as Ohm's Law. There are three forms of Ohm's Law. The first tells us that the current in a circuit is equal to the potential (volts) divided by the resistance (ohms). The second tells us that the resistance in a circuit is equal to the potential (volts) divided by the current (amperes), and the third tells us that the volts equal the amperes times the ohms. We will learn the application of these three formulas as we progress further into the subject of short-wave radio.

PRODUCTION OF AN ELECTRIC CURRENT

In the foregoing discussion, we have referred to a force (E.M.F.) that would cause electrons to be separated from atoms and move through a conductor to other atoms. This E.M.F. can be maintained by means of a battery or a generator. The former consists of plates of certain materials immersed in certain solutions that cause a chemical action, resulting in the production of free electrons at one of the plates. We will not go into the details of these chemical actions at this time. The interested radio fan can find this information in books on electricity or batteries. Several common types of batteries are shown in Fig. 6.

The other common source of E.M.F. is a generator which depends on the effect of induction and magnetism. We already en-

countered the effects of induction when we noted that the pith ball was attracted by the glass rod, even though it was not touching it in any way. Inductive actions are very important in radio, in tuning coils, transformers, etc.

MAGNETISM

When a current flows through a conductor, two principal effects can be noticed. The first is that heat is produced. The current encounters a certain opposition (resistance) in the conductor and part of the electric energy is used up in overcoming this "frictional" resistance. The energy used up in this manner makes itself evident in the form of heat.

The second effect is known as magnetism and we can best illustrate this by considering Fig. 7. This illustration shows a coil of wire wound around a bar of soft iron. A current from a battery is flowing through the coil. While the current is flowing, the iron bar will be found to have the power of attracting small pieces of iron and steel. When the current from the battery is not flowing, the iron bar no longer attracts the iron pieces. Thus we can see that the current passing through the coil of wire has given it a new property which we call *magnetism*, and since it has this property only when the electric current flows, we call it an *electromagnet*.

Now, if we replace the soft iron bar with one of hard steel and allow the current to flow for some time, we will find that the steel will attract the pieces of iron even when the current flow has stopped. We have now made a *permanent magnet*. A careful examination of the soft iron bar will show that it also retains a small amount of magnetism, although in a smaller degree than the steel. The steel is said to have a higher degree of retentivity than the iron.

If we drop a permanent magnet into a box of iron filings, we will notice that there are two places on the magnet to which the most filings cling. See Fig. 8. These places near the ends of the steel bar are called the *poles* of the magnet. One pole is called the north pole and the other the south pole, or more accurately the north-seeking pole and the south-seeking pole, for if we suspend the magnet from a thread, it will swing around until the north-seeking pole faces the north and the south-seeking pole faces the south. This is the effect used in the magnetic compass.

Magnets and magnetism are used in a number of different ways in radio receivers. Headphones and loud speakers contain magnets. The transformers used in radio amplifiers depend on magnetism. Even the actual transmission and reception of the radio waves depends on magnetic principles.

(Continued on page 52)

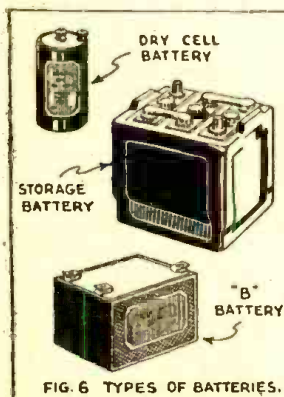

FIG. 6 TYPES OF BATTERIES.

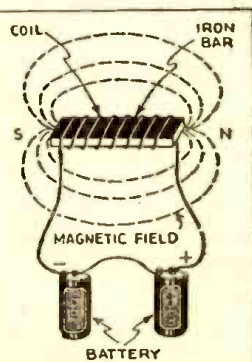

FIG. 7 ELECTRO-MAGNET

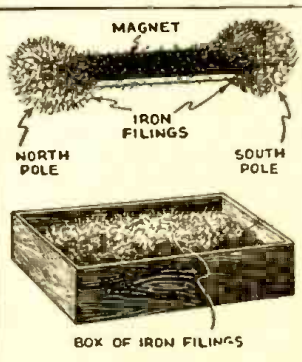

FIG. 8 DEMONSTRATING POLES OF A MAGNET.

Now is Your Chance!

NEVER before in our history has there been such a demand for RADIO CODE OPERATORS! . . . You may never again have this opportunity! . . . Army, Navy, Merchant Marine and Industry need trained Radio Code Operators now! . . . this is your chance to train right in your own home, with the same training that has put thousands of code operators into good paying positions. . . The Candler System can train you with their easy, practical method that will give you unlimited opportunities . . . no expensive practice sets needed —costs you nothing to investigate . . . no salesman will call. . . . WRITE TODAY!

FREE BOOK! Send a post card today for The Candler free BOOK OF FACTS . . . tells you all the facts about being a radio code operator. Your copy is waiting for you—WRITE FOR IT TODAY!

CANDLER SYSTEM CO.
BOX 928
Dept. 5-10, Denver, Colorado



READ and SEND CODE

Learn Easily at Home This Quicker Way

No experience needed. Beginners read code quickly, copy accurately. If already an op., speed up your work with this approved training all Electric Master Telex Code Teacher. Only instrument which records your sending in visible dots and dashes on specially prepared paper tape—then sends back your own key work at any speed you wish. NO PERFORATIONS—NO INK. Far superior to anything ever developed. Fascinating, foolproof—gets results because you learn by HEARING as well as SEEING. That is why thousands agree this method is surest and quickest. While not designated standard equipment, Telex is used at many U. S. Army Posts, Naval Training Stations. We furnish Complete Course, lend you the New All Electric Master Telex and Personal Instruction with a MONEY-BACK GUARANTEE. Low cost, easy terms. Write today for folder S 9; no obligation.

TELEPLEX CO., 167 HUDSON ST. JERSEY CITY, N. J.

Do you need BINDING POSTS?



The XL PUSH POST with its Spring Action assures Constant Contact and quick connection.

Manufactured in All Aluminum Type M at 12c each.

Aluminum Body, Bakelite Top Type B1 at 15c each.

Types CP or NP. ALL BRASS—STAINLESS STEEL SPRING & PIN PROVEN by 240 HR. SALT SPRAY TEST as NON-CORROSIVE at 28c each.

Manufacturers and Dealers Liberal Discounts

X. L. RADIO LABORATORIES
420 West Chicago Ave., Chicago, Ill.

Correspondence Courses In RADIO and ELECTRICAL ENGINEERING

ELECTRICAL ENGINEERING Get good crash course of wide electrical field. Prepare yourself, at Low Cost, for secure future. Modern simplified, you can understand quickly.

RADIO ENGINEERING Extra fine course in radio, publication address, photo-electric work. Train you to be super-service man, real vacuum tube technician. Exper. kits furnished. Diploma on completion. Tuition, \$25. either course. Deferred payment plan. Get copies of school catalog, student magazines, complete details. SEND NOW!

LINCOLN ENGINEERING SCHOOL Box 931-C45, LINCOLN, NEBR.

COMMERCIAL RADIO INSTITUTE

A radio training center for over twenty years. Well equipped. Excellent faculty. Practical resident courses in Defense, Radio Telegraphy, Broadcast, Servicing, Industrial, Television, Aeronautical, Drafting, Mathematics and Studio Technique. Placement bureau. Fall classes now forming for October 5. Catalog upon request.

Dept. D, 38 West Biddle Street, Baltimore, M.I.

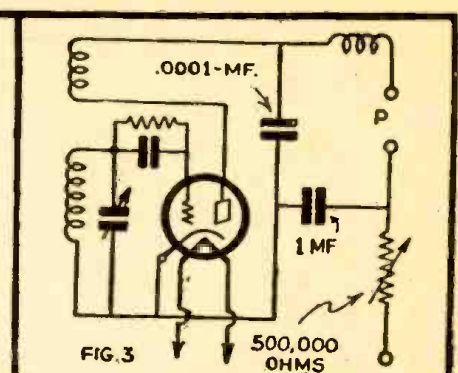
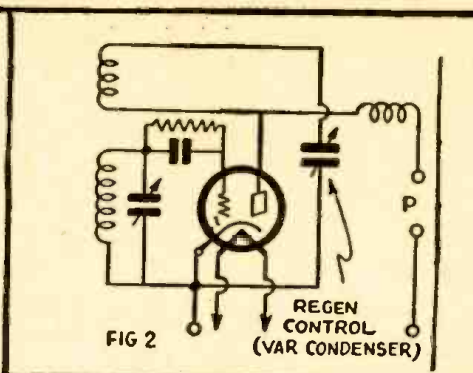
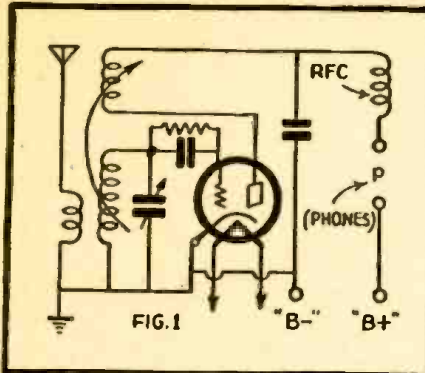

WHICH REGENERATION SCHEME?

By M. HARVEY GERNSBACK

ONE of the most important factors in short-wave receiver design is *regeneration control*. Unless a set has an efficient method for controlling regeneration it is well nigh useless. A discussion of various methods of control and their advantages and disadvantages will be undertaken in this article.

Detector systems using three-element tubes will first be discussed. For simplicity, all diagrams will show grid returns to cathode, which is equivalent to A-minus filament in battery sets. Figure 1 shows the simplest system of control, by mechanical movement of the tickler coil with respect to the grid coil. This method is now obsolete, as it is very critical in adjustment and causes quite a noticeable *detuning* effect on the detector tuning control. Figure 2 shows a method that was once considered the best possible for short-wave work. It is used but little at present, as it also is fairly critical in adjustment and causes detuning. It is simply a parallel plate feed system similar in principle to the method of isolating the plate current from an A.F. transformer primary in audio amplifiers.

The control shown in Fig. 3 merely varies the voltage applied to the detector plate by means of a variable resistor. This control is likely to be very noisy and in addition it gives only rough control, together with detuning effects, all of which makes it unsatisfactory for high efficiency. In Fig. 4 is shown a method which, although it has negligible detuning effects, is not very satisfactory because of its critical and not always noiseless operation. Figure 5 illustrates what is probably the most generally used form of control. If carefully designed it will usually prove a very quiet and smooth form of control. Noisy variable condensers cause trouble frequently and in addition there is a pronounced detuning effect.

Figures 6 and 7 illustrate two entirely different methods of control. The exponents of the scheme shown in Fig. 6 claim that it is free from detuning effects, is very quiet in operation and gives a very smooth control of regeneration. The method of control illustrated in Fig. 7 also gives very satisfactory results, according to reports. We have not yet experimented with it, however, so we are not able to give definite statements as to its merits, but it is certainly worth a trial.

Recently quite a number of set builders

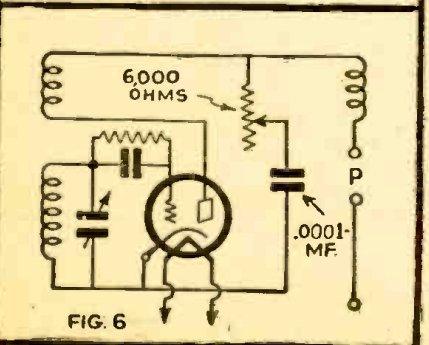
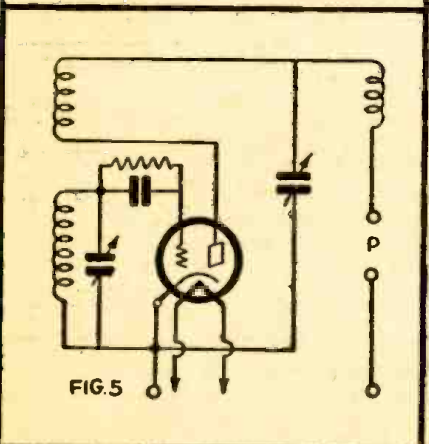
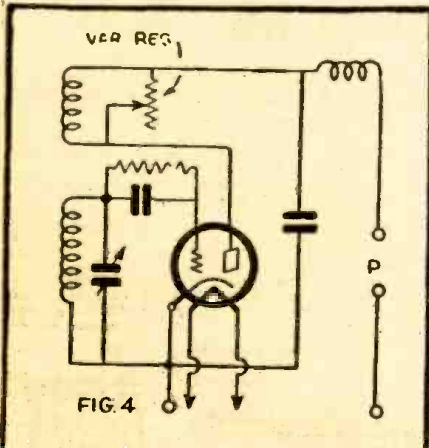
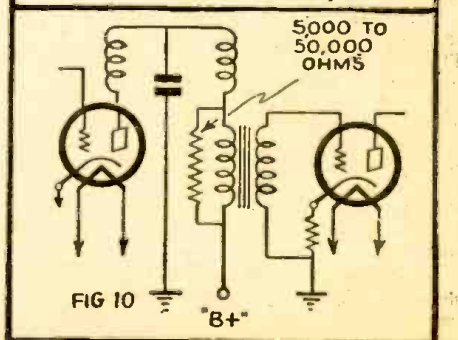
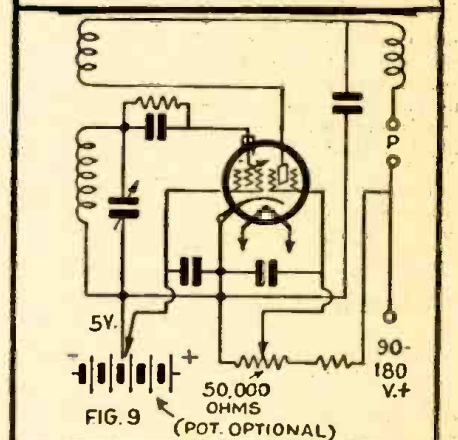
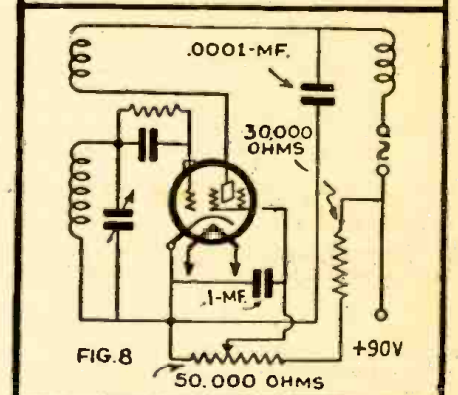
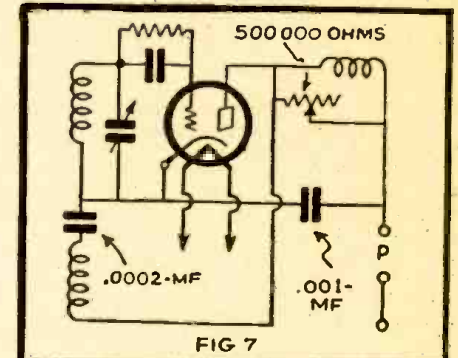

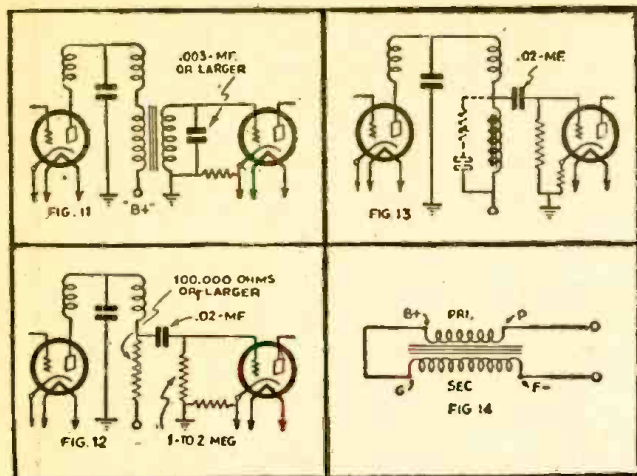

have advocated the use of screen-grid and R.F. pentodes in the detector stage. These tubes, when properly used, give much stronger signals than triodes and offer much more efficient methods of controlling regeneration. All of the methods of control discussed under three-element tubes may be used with these tubes and will give much stronger signals. There is a much better system of control for these tubes, by varying the potential applied to the screen-grid. This method gives very fine control with none of the objectionable features of the methods of control described above. Figure 8 shows how the screen voltage is varied by a potentiometer. A variable- μ tube used as detector in this circuit will give even better control than an ordinary screen-grid or pentode tube.

The use of the R.F. pentode as detector has only recently been considered, because of lack of R.F. pentodes in the open market. This tube should prove even more efficient as a detector than the screen-grid tube, especially when provision is made for varying the potential on the suppressor grid as well as on the screen grid. The suppressor grid potential should be adjustable so that positive as well as negative potential may be applied. This control need only be adjusted when first operating a receiver, as once the best point is found there is no further need of adjustment unless tubes or the circuit is changed. We would like to hear from experimenters as to what results they have had using these new tubes. (See Fig. 9.)

One of the most troublesome things in a regenerative detector system is *threshold howl*—a strong audio frequency howl which

occurs just before the receiver goes into oscillation. As the period just before oscillation is the most sensitive of operation, *threshold howl* effectively ruins a receiver's efficiency. The reasons for *threshold howl* are not very well understood, but there are several methods of eliminating it. Figures 10 and 11 illustrate methods of curing this condition when a transformer is used for coupling to the audio amplifier. Both of these methods result in reduction of volume, but they are necessary if the receiver is to function properly.

If resistance or impedance coupling is used between detector and audio system, *threshold howl* is not present. This is the most satisfactory method, as the systems illustrated in Figs. 10 and 11 affect the audio response. Figure 12 shows a *resistance* coupling system. It is necessary to apply at least 180 volts to the plate of the detector, due to the drop in the resistance. Figure 13 is a form of *impedance* coupling. This is the best method for all-around use, as the voltage drop through the plate impedance is very slight and a fairly low plate voltage may be applied to the detector. When using a screen-grid or pentode tube as detector, it is almost imperative to use the impedance method, due to the high plate impedance of these tubes. By connecting the primary and secondary of an A.F. transformer in series as shown in Fig. 14, a satisfactory plate impedance may be secured. It may be necessary to shunt this impedance with a resistance in series with condenser, as shown by the dotted lines in Fig. 13. This is to cut the high note response. It is also possible to use a high impedance choke coil in place of the audio transformer.

TRANSFORMERLESS POWER SUPPLIES

(Continued from page 25)

while that across C_8 is very nearly equal to the line peak.

These two capacitors discharge in series, affording their combined voltage drops. Thus, the voltage presented to the load resistance R is the sum of the voltages appearing across C_7 and C_8 —approximately three times the line peak.

In the tripler circuits, the ripple frequency corresponds to that of the line because of the asymmetry of the arrangement. Filtering procedure is therefore the same as for the simple half-wave transformerless circuit.

In the second voltage tripler circuit, shown in Figure 5, the four diodes of the two tubes are connected in a full-wave doubler-full-wave rectifier circuit in a manner somewhat similar to the foregoing cir-

cuit. Constants given in the diagram are those employed by the editors in an experimental set-up. An output voltage-load current curve for this circuit is given in Figure 6.

HALLICRAFTERS AWARDED ARMY AND NAVY "E"

The Hallicrafters Company was notified last month by Under Secretary of War Robert P. Patterson that it has been awarded the Army and Navy "E" Banner, according to an announcement by W. J. Halligan, president of Hallicrafters.

The company was complimented in Mr. Patterson's notification letter for the "high achievement attained in the production of war equipment. The high and practical patriotism of the men and women of The Hallicrafters Company is inspiring. Their record will be difficult to surpass, yet the Army and Navy have confidence that it was made only to be broken."

THANKS TO YOU, MISTER SERVICEMAN

From the first SUPREME instrument, and through the fourteen years since, the acceptance, loyalty and co-operation of servicemen everywhere are largely responsible for the excellence of SUPREME instruments today—and our ability to produce them in quantity for our armed forces. If you could not get the new equipment you wanted this year, just remember that it is now doing duty for us in some spot on the globe and represents part of your contribution to Victory.

Many Jobbers still have SUPREME Instruments in Stock. Tell us the instrument you want. We'll do our best to get it for you.

SUPREME
INSTRUMENTS CORP.
GREENWOOD, MISSISSIPPI, U. S. A.

WHY GROPE?

You Can Get That **BETTER RADIO JOB**



—insure your present position with the help of CREI home study training in **Practical Radio Engineering!**

Don't play "blind man's bluff" with your future! Take advantage of today's opportunities to increase your technical ability... not only to meet the demands of your present job, but to rise to a still better job. There are good technical positions for experienced, trained radio-men in manufacturing, broadcasting, aviation and governmental fields. CREI home study courses can help you acquire the necessary technical knowledge to hold on to that new job you now have—and to qualify for the better, higher-paying positions that await you. Act now.

WRITE FOR FACTS TODAY!

Our free booklet and personal recommendations may hold the answer to your success. In your inquiry, please state briefly your background of experience, education and present position.



CAPITOL RADIO Engineering Institute

Dept. RC-10, 3224 16th Street, N. W., Washington, D.C.

LEARN RADIO TELEVISION

600 LICENSED graduates placed in past 7 years in shipping, broadcasting, aviation, police, etc.; we also teach radio servicing and repairing; new beginners' class forming Sept. 8th; 60-page catalog free; oldest, largest and best equipped.

MASS. RADIO SCHOOL

18 BOYLSTON ST., BOSTON, MASS., Est. 1899

RADIO TECHNOLOGY



RCA Institute offers an intensive two-year course of high standard embracing all phases of Radio and Television. Practical training with modern equipment. Also shorter specialized courses in Commercial Radio Operating, Radio and Television Servicing, and Aviation Communications. For Free Catalog write Dept. RC-42.

RCA INSTITUTES, Inc.

A Radio Corporation of America Service
75 VARICK STREET NEW YORK

RADIO COURSES

Start Sept., Day and Evening Classes

- RADIO OPERATING • RADIO AMATEUR CODE • RADIO SERVICING • RADIO TECHNICIANS

New York Y.M.C.A. Schools

4 W. 64th Street New York City

AMPLIFIERS AND PARTS

GUARANTEED IN ABSOLUTE PERFECT MECHANICAL AND ELECTRICAL CONDITION, ALTHOUGH SLIGHTLY USED.

Photo shows 30 watt ampl. # 104A



All ampl. shipped Ready to operate

102A—12 WATT PUSH-PULL 2A3 AMPLIFIER
Frequency response plus or minus 2DB. from 30 to 15,000 CPS. bass and treble boost. Inputs for phono pick-up or radio tuner. Output impedance 8 or 16 ohms to P.M. or Electro-Dynamic speakers, supplies field current for one or two 2500 ohm speaker fields. An excellent amplifier for FM or recording. **\$18.45**

102—12 WATT PUSH-PULL 2A3 AMPLIFIER
Same as above, but without stages of crystal pick-up. Schematic furnished free to change unit over to these stages. To be used with one or two 2500 ohm dynamic speakers 16 ohm voice coil. May be changed over to use P.M. speakers. Input for magnetic pickup. Variable tone control. **\$8.75**

Shipping Weight 25 lbs. for either of above

103A—20 WATT PUSH-PULL 6L6 AMPLIFIER
Input for one crystal or dynamic microphone. Input for one crystal or magnetic phono-pick-up. Full range tone control. Frequency response 30 to 10,000 CPS. Output impedance 8 or 16 ohms to PM or Electro-Dynamic speakers, supplies field current for one or two 2500 ohms speaker fields. **\$15.95**

103—20 WATT PUSH-PULL 6L6 AMPLIFIER
Same as above, but without stages of crystal pick-up and crystal microphone. Schematic furnished free to change unit over to these stages. To be used with one or two 2500 ohm dynamic speakers 16 ohm voice coil. May be changed over to use P.M. speakers. Input for magnetic pickup. Variable tone control. **\$9.85**

Shipping Weight 24 lbs. for either of above

104A—30 WATT PUSH-PULL 6L6 AMPLIFIER
Input for two crystal, dynamic or velocity microphones individually controlled. Input for crystal or high impedance phono pick-up. Full range tone control. Frequency response 30 to 10,000 CPS. Output impedance 2.6, 3.2, 4, 5.3, 8 and 16 ohms to P.M. or Electro-Dynamic speakers, supplies field current for one or two 2500 ohm speaker fields. **\$21.45**

104—30 WATT PUSH-PULL 6L6 AMPLIFIER
Same as above, but without stages of crystal pick-up and crystal, dynamic or Velocity Microphone. Schematic furnished free to change unit over to these stages. Has input for magnetic pickup, volume control, variable tone control. Supplies field current to one or two 2500 ohm dynamic speakers, output impedance 2.6, 3.2, 4, 5.3, 8, and 16 ohms. Full 30 watts output. **\$12.05**

Shipping Weight 26 lbs. for either of above
All Amplifiers Less Tubes & Speakers.



JENSEN 10 INCH ELECTRO-DYNAMIC SPEAKER
2500 OHM FIELD
16 OHM VOICE-COIL

EACH **\$2.95**
Shipping Weight 7 lbs.

ORDERS SHIPPED SAME DAY AS RECEIVED. All goods are sent Express collect if no money for Parcel Post is included in remittance. Customers in Foreign countries are requested to remit in U. S. Currency or International Money Orders and include enough money to ship goods prepaid. Order from this ad. 25% deposit required on all C.O.D. orders.

PEERLESS RADIO AND SOUND CORP.

11 So. Desplains St., Dept. 1042 CHICAGO, ILL.

NEUTRALIZING CONDENSER

Kink number one is a homemade neutralizing condenser for small tubes such as 6L6, 2A5, etc. Take a piece of copper tubing of 3/16" size as one plate and use a piece of well insulated wire for the other plate. The copper tube is about 4 inches long, and the capacity can be varied by pushing the wire into the tube or pulling it out.

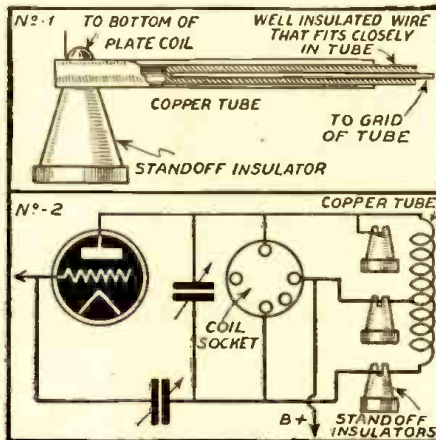

Kink number two is the use of two coil mounts for one stage in a Xmitter. The idea came to me when I found that I could get much more output on 10 meters with a self-supporting copper tube coil, than with a coil wound on a coil form of the plug in variety. I use a T-40 as the final on 10 meters but when operating on the other bands the T-40 stage becomes a buffer amp. and feeds a 203A final. As the 203A is link coupled to the T-40, a coil of the plug-in variety was found to be the best suited to the case. I wired in a coil socket for the plug-in coils in parallel with the standoff insulators, which have large jacks for the copper tube coil.—George Levensator, W1DPJ.

PLUG-IN COIL

Here is an economy for radio beginners who have bought plenty of 45 volt "B" batteries of the plug-in type. I use a plug and

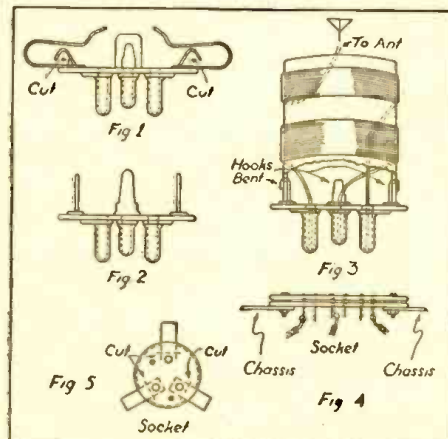

a socket taken from a useless 45 volt "B" battery. From the plug, I cut off the clips (Fig. 1) leaving only the hook straightened up as in Fig. 2. Now take a cardboard tube of one inch diameter and make three small holes near the base to suit the location of the hooks. Bend the hooks through

the holes so that the coil form is held intact to the plug. Then wind your coil and solder the ends of the wires to the prongs of the plug. In the case of Eveready plugs, the prongs are hollowed. Since there are three prongs, the terminal leading to the antenna can be left hanging as in Fig. 3.

The socket may be used like an ordinary socket to suit the purpose. Cut off the metal strips as in Fig. 5, and mount on the chassis. The terminal of the socket would serve as the terminals for the corresponding leads as in Fig. 4—A. Locilio.

B.F.O. CODE-PRACTICE KINK

It is common practice to turn on the b.f.o. of a receiver so that it makes a whistle with a station, connect a key in series with the earphones, and practice code. Very frequently, however, this is not satisfactory as there is so much capacity between key components and earphone wires that the station can be heard fairly well even with the key up. This of course makes code practice difficult as the keying is hard to read.

With the circuit illustrated the phones are shorted out when the key is up so that there is no sound in the phones until the key is pressed down, unshorting the phones.

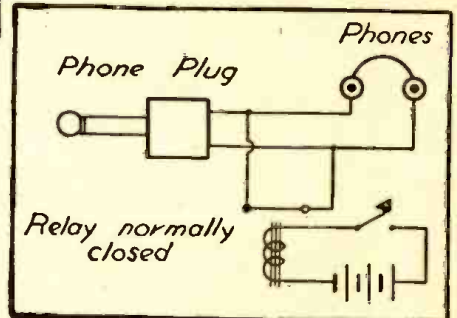

The keying is very clean therefore and is easily readable, being very sharp. Be sure you have the right type of relay for this circuit, one that is normally closed.—Franklin Williams, W6ULE, Glendale, Calif.

TRACKING DOWN GRID EMISSION

(Continued from page 14)

The presence of grid emission is usually indicated by distortion, increase in hum, and excessive plate current. It is sometimes difficult to detect the presence of excessive plate current unless the meter is permanently in the circuit during tests, as the switching-off of the tube may allow it to cool sufficiently to restore normal operation. For this same reason grid emission cannot be detected on tube checkers.

In performing tests to determine grid emission the receiver should be thoroughly heated, not by applying excessive line voltage which might damage condensers and other parts, but by placing a box over the chassis so that ventilation is cut off.

A microammeter, having a 0-10 scale, connected in series with the grid return circuit is the most practical method of measurement. However, this instrument is expensive and delicate and is not easily obtainable.

A milliammeter, which we all have, permanently connected in the plate circuit will show a rise in current after the receiver is sufficiently heated if grid emission is present.

Practical cures for this ailment may be effected by a diode gate, a resistor in series with the filament to slightly reduce the filament voltage, proper ventilation, automatic bias. Above all, make sure that the values of voltages and grid resistors are within the ratings of the tubes.—Sylvania News.

A New Type of Service Manual!

RADIO CIRCUIT MANUAL - 1941

**The Only EDITED Manual
Ever Published!**

DIRECTORY OF RECEIVERS MANUFACTURED IN 1940 AND UP TO JUNE, 1941

MORE INFORMATION IN HALF THE NUMBER OF PAGES

The value of a service manual is measured not by the number of pages but by the amount of useful information. Thus, in only 736 pages this Radio Circuit Manual covers over 200 receiver models MORE than does any other competitive manual in twice the number of pages.

HOW DID WE DO IT? . . .

. . . By Increasing the size of our page; by discarding non-essential data and editing the balance; by listing only those receivers which the Service Engineer will definitely have to repair (no communications or export receivers, no shortwave sets or amplifiers, no electronic devices, etc.); by many months of hard work based on a definite plan of procedure and a clear understanding of the actual requirements of the Service Engineer. There is no "dead weight" information to add bulk to this Manual. Every word counts. Every minute of reading time is well spent.

OUTSTANDING FEATURES

- Contains data on more than 1800 receiver models!—more than any other radio service manual.
- Only 736 pages!—less than half the bulk of any other manual and more than 1/3 lighter.
- All information is EDITED!—all non-essential data deleted and the balance checked and correlated with the schematics and sketches.
- 40% larger page permits listing of all information on one page. (A few unavoidable cases excepted.)
- I.F. peaks for all superhet circuits are boldly displayed in black boxes;—none missing, all accurate.
- No space wasted on communications and export receivers, amplifiers, electronic musical instruments, etc.—a 100% Service Engineer's Manual.

A "CUSTOM-TAILORED" MANUAL FOR SERVICE ENGINEERS

Here, at last, is a Service Manual deliberately PLANNED for the Service Engineer. Instead of a mere hodge-podge collection of service data, as manuals have been in the past, this RADIO CIRCUIT MANUAL is an orderly compilation of essential radio diagrams and service information, carefully edited and uniformly presented for the maximum convenience of the busy Service Engineer. All time-consuming, non-essential data have been weeded out, and the remaining information, vitally important to the rapid and efficient servicing of modern radio receivers, has been laid out in a logical, easy-reading style which cuts time from the day's work. Because of this and other features which are self-evident upon first observation, it has been possible to list all information pertaining to a given model on a single page.

In 736 pages this Manual presents essential service data on over 1800 receiver models;—more than any other existing service manual on the market!

ONLY ONE MANUAL PER YEAR!

The new technique used in compiling this RADIO CIRCUIT MANUAL—1941 makes it possible to include in a single book all the new receiver models which the radio industry can produce in a single year. This factor alone represents an important saving to all Service Engineers.

A PERMANENT INSTITUTION

This Radio Circuit Manual—1941 is NOT a one-time proposition. Next year there will be a Radio Circuit Manual—1942, the following year, 1943 and so on indefinitely—each Manual better than the other as new methods are worked out for expediting and simplifying the work of the practicing Service Engineer.

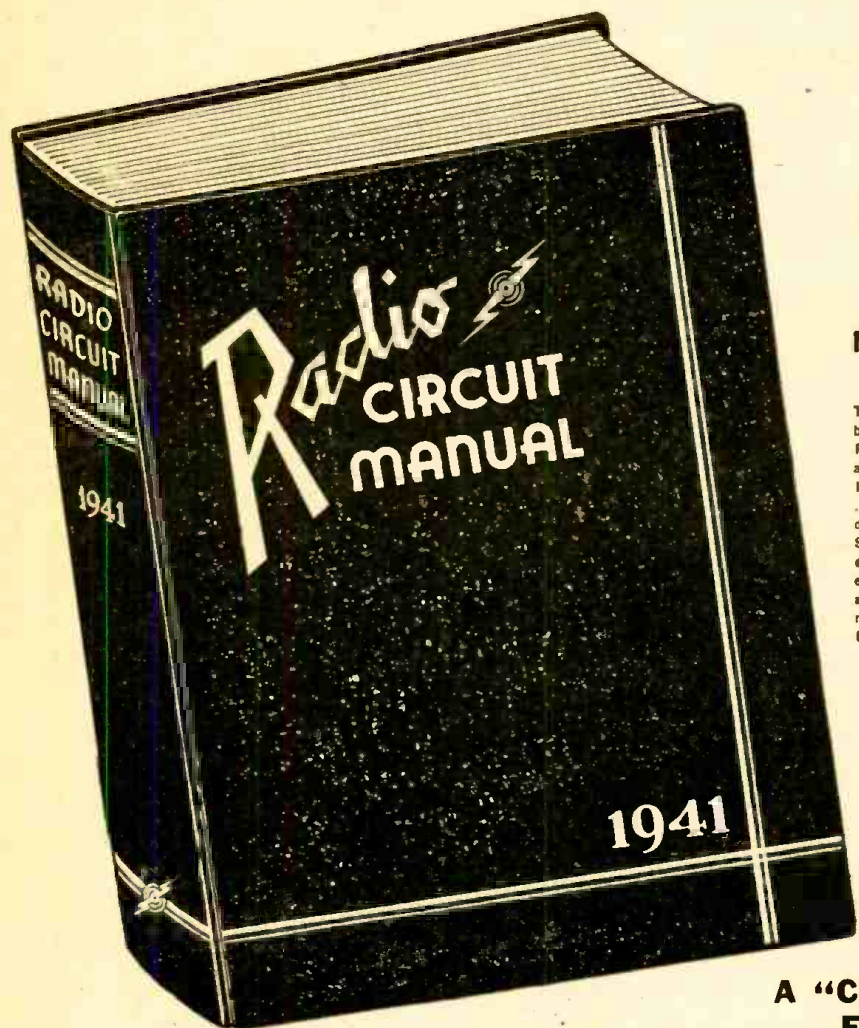

← THE OLD TYPE MANUALS—Bulky, heavy, hard to handle, space consuming, less USEFUL data despite greater number of pages.



→ OUR NEW MANUAL—Lighter, compact, easy to handle, takes half as much room on the shelf, more USEFUL information despite fewer number of pages.

MANUALS NOW READY!

RADCRAFT PUBLICATIONS, INC.,
25 West Broadway, New York, N. Y.
Gentlemen: Enclosed find my remittance of \$10.00, for which send me, POSTPAID, my copy of the RADIO CIRCUIT MANUAL—1941.

Name
Address
City State
RC-10-42

(Send remittance in form of check or money order; register your letter if you send cash.)

ORDER YOUR MANUAL IMMEDIATELY—NOW!

Get your copy directly from us by filling out and mailing the convenient coupon shown at left, or get it directly from your favorite distributor.

736 pages; size 13½ x 10¼ x 2 in. thick; loose leaf, leatheroid-covered stiff binder; net weight 6½ lb.

ONLY
1000

RADCRAFT PUBLICATIONS, INC.

25 WEST BROADWAY

NEW YORK, N. Y.

\$\$\$\$\$\$\$\$\$HALLICRAFTERS\$\$\$\$\$\$\$\$\$

\$\$\$\$\$\$\$\$\$HALLICRAFTERS\$\$\$\$\$\$\$\$\$

\$\$\$\$\$\$\$\$\$HALLICRAFTERS\$\$\$\$\$\$\$\$\$

WANTED!

HALLICRAFTERS

RECEIVERS AND TRANSMITTERS!

Do Your Part! If you have any modern apparatus, don't put it away in moth balls for the duration. Put it to work for **VICTORY!**

Send a detailed description of your station to **HARRISON to-day!** Give age, condition and photographs (if available). We will pay you **immediate cash!** Remember!

Development of new radio equipment is being rapidly accelerated under the pressure of military requirements.

All signs point to radically different gear when this war is over. Don't be an antique collector!

You can buy Defense Bonds with the money!

HARRISON RADIO CO.
12 WEST BROADWAY - NEW YORK CITY

\$\$\$\$\$\$\$\$\$HALLICRAFTERS\$\$\$\$\$\$\$\$\$

GETTING STARTED IN RADIO

(Continued from page 47)

INDUCTION

One of the greatest discoveries in electricity was the fact that a magnetic field in motion will cause a movement of electrons which we know as an electric current. If we connect a coil of wire across an indicating instrument (such as a galvanometer, which indicates the presence of current) and run a permanent magnet through the end of the coil, the needle of the galvanometer will move, indicating the presence of current in the coil. The needle of the meter will quickly return to the zero position when the magnet is at rest in the coil. Then if we draw it out again quickly, the galvanometer needle will again move, but this time in the opposite direction. It will be found that the faster the magnet is moved, the greater will be the deflection.

If we substitute a piece of unmagnetized steel for the magnet there is no current indicated. The difference between the magnet and the steel is the presence of the magnetic lines of force surrounding the former. This experiment shows that whenever a conductor is placed in the presence of a moving magnetic field, a current is produced. This current is caused by *induction*.

CURRENT PRODUCES SIMILAR EFFECT

A similar action can be obtained if the magnetic field is produced by a current instead of a permanent magnet. Suppose we wind two coils and place them end to end closely together, one coil being connected to the galvanometer and the other to the battery, with a switch to open the battery circuit. When we close the switch, the galvanometer indicates a momentary current. Then open the switch again and the galvanometer needle shows another current, opposite to the first.

If we insert a piece of soft iron through the coils, the action is the same as before, but much stronger. This is the principle of the tuning coils and transformers used in radio reception. It will be noticed that we did not move the coil as we did the magnet. The magnetic field, building up in the coil when we closed the switch, gave the necessary "moving" field to induce the current in the second coil or the secondary, as it is called.

DIRECT AND ALTERNATING CURRENT

Up to this time, we have limited our discussion to currents flowing in one direction in a conductor. This type of current is known as direct current. It will be remembered that when the magnet was plunged into the coil and withdrawn, the current reversed its direction when the magnet was withdrawn. To state this in another way, we can say that the direction of the current was alternating in one direction and then in the other. This type of current is known as an alternating current.

Alternating currents are used extensively in radio. In fact, the radio waves themselves are alternating currents which reverse very fast, in the neighborhood of 1,000,000 times per second or even more. Currents which have a frequency (reverse their direction of flow) of less than 10,000 cycles (complete reversals) per second are known as audio frequencies, and those over 10,000 cycles per second as radio frequencies.

It is suggested that the reader perform the various experiments in this discussion in order to fix the facts firmly in mind, as these principles are all directly applicable to the operation of radio apparatus.

LAST CHANCE

that you will have to buy

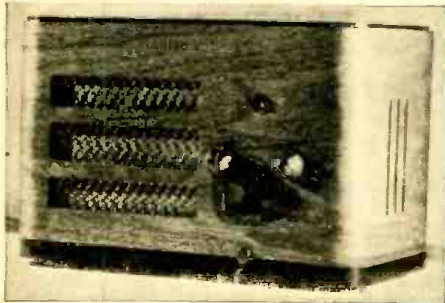

Complete two-way wireless loud speaking system. Perfect performance. Plug into any 110 volt house socket A.C. or D.C. Equipped with Call-Listen-Talk switch and volume control.

No installation charges. Modulated carrier signal travels over the electric light lines. **IDEAL FOR OFFICES, STORES, FACTORIES, SCHOOLS, LIBRARIES, HOMES AND WHEREVER INTERCOMMUNICATION IS DESIRED. EXCELLENT SPEECH CHARACTERISTICS.**

Each unit is housed in beautiful 2 tone veneered cabinet with grided speaker front.

This Coupon is worth \$2.00 if mailed to us with order **BEFORE Oct. 15/42.**

Name

Address

City

Crosley CHATTABOX
INTERCOMMUNICATION SYSTEM OF TWO UNITS FOR **\$24.75**
LIST PRICE—\$59.50 A PAIR

KORROL MFG. CO.
350 GREENWICH ST. (DEPT. RC8)
NEW YORK CITY

BIG FREE CATALOG



EVERYTHING IN RADIO

Sets, parts, supplies, public address systems, amateur equipment, testers, kits and fluorescent lighting at lowest prices. Huge stocks, bought months ago ... ready for shipment the same day your order is received. The Defense Program is making big demands on our industry but because of our advance buying we are able to fill your orders promptly and efficiently.

BURSTEIN-APPLEBEE COMPANY
1012-14 McGEE, KANSAS CITY, MO.

If It's a CANNON-BALL It is a GOOD HEADSET



Scientifically Built Heavy bar magnets greatly increase their efficiency.

For clarity of tone use Cannon-Ball sensitive phones. Assure dependable performance. Guaranteed to give absolute satisfaction. Write Headset Headquarters for folder C-9 illustrating complete line.

C. F. CANNON COMPANY
SPRINGWATER, N. Y.

WIDE RANGE FILM RECORDING

(Continued from page 33)

quite expensive if the recording involved a symphony.

One of the problems encountered by the Ozaphane developers was the distortion in loudspeakers. This fact, coupled to the difficulty of obtaining suitable microphones, caused them to decide on an upper range for commercial reproductions of 12,000 cycles. It will be noted from the sound-frequency characteristics chart that modern electrically recorded discs for home phonographs are capable of going only to 5,000 cycles. The fact that such recording are assumed to be able to go down to 60 cycles is of little value, because the lower frequencies must be attenuated to avoid over-cutting in the recording process. With Ozaphane, however, the lower limit is governed principally by the reproducing amplifier and speakers.

At a private demonstration given recently before a group of musicians, the Ozaphane process was compared with a high-priced phonograph radio combination. The reaction of the persons who listened to this demonstration was that some trickery was resorted to—so great was the difference.

The photo-electric mechanism is no different from any similarly used equipment, except of course that the amplifier needs to have an exceptionally wide frequency response and must be relatively low in distortion. This will be understood when it is realized that any distortion generated in the amplifying process creates harmonics—generally second and third harmonics—and since these harmonic frequencies extend into the higher range, they will alter the quality of the reproduced music by giving spurious overtones. The use of negative feedback to reduce amplifier distortion will be necessary in the amplifiers for the new system.

The recent developments in loudspeakers, brought about by the introduction of frequency modulation, would indicate that the two speaker systems—the woofer and tweeter—will be necessary, and it is hoped that speaker manufacturers will be able to lower the distortion of present designs or provide new designs which could be used for the new type of home equipment.

DEVICES FOR AIR RAID WARNINGS

(Continued from page 38)

tions in the atmosphere. The amount of moisture in the air, the temperature, the direction and velocity of the wind, the presence of ascending or descending air currents, the existence or absence of stratified layers, all affect the transmission of sound through the air.

It has been observed that under favorable atmospheric conditions a powerful signal may be heard many miles. In fact, some of the devices on which the bureau is reporting have been heard for distances up to 8 miles, yet under some of the unfavorable conditions mentioned above they have not been heard for one-quarter of a mile. On account of these atmospheric vagaries it would seem that a number of medium-sized signaling devices, spaced in some form of a grid pattern, would give a more positive coverage than a few very large devices spaced relatively far apart.

TUBE DIVISION NAME CHANGED

The Vacuum-Tube Division of the General Electric Radio, Television and Electronics Department will henceforth be known as the Electronic Tube Division, according to a recent announcement by Dr. W. R. G. Baker, vice-president in charge of the Department.

Headquarters for HALLICRAFTERS EQUIPMENT



WE CAN ALL HELP WIN THIS WAR!

WE ARE busy supplying our government with new and used communications receivers and transmitters urgently needed.

That is why we are paying highest cash prices for used communications equipment.

You can help win this war by contacting us at once if you are willing to convert your equipment into cash.

Remember—after the war, you will want a new receiver. And you can buy a new and better receiver with what we will pay you.

Write, telephone or telegraph us description of your used communications receivers and transmitters of standard make; you will be paid cash immediately without bother or red tape.

We also have a store at 2335 Westwood Blvd., West Los Angeles, Calif.

COMPLETE STOCKS
 * We still have large stocks of receivers, 2½ meter equipment, meters, tubes, transformers, resistors, condensers, panels, chassis, and radio parts of all sorts. We sell and rent code teaching equipment. Your orders and inquiries invited.

Bob Henry, W9ARA

HENRY RADIO SHOP

BUTLER, MISSOURI

"WORLD'S LARGEST DISTRIBUTOR OF COMMUNICATIONS RECEIVERS"

The Book that takes Drudgery out of Mathematics

Only 50¢ postpaid

ELEMENTARY MATHEMATICS

SOLVES EVERYDAY PROBLEMS—HELPS YOU GET AHEAD IN LIFE

How many times have you lost money because of a mistake in figuring? Do you know how to figure quickly and correctly? Can you figure discounts, interest rates, taxes and all the other calculations you meet up with in your daily life?

Are you having trouble qualifying for Army or Navy promotion because you're not up on mathematics?

Here is the book that gives you a good background in mathematics; that takes all the irritation and drudgery out of it. You don't need to be scared of mathematics, because here's the subject explained without frills, without useless computations.

Here's the book for men in the armed forces: for business men; technicians and craftsmen, explaining and answering everyday mathematic problems in easy-to-understand words and illustrations.

Yes, it's the key to a simple understanding of mathematics. It's a real home-study course in mathematics for the man who's alert to the importance of mathematics in the world today.

ELEMENTARY MATHEMATICS

● EASY — SIMPLIFIED — PRACTICAL ●

- CONTENTS OF BOOK**
- CHAPTER I. Arithmetic—Addition—Subtraction—Multiplication—Division.
 - CHAPTER II. Factoring and Cancellation—Fractions—Decimals—Percentages—Ratios and Proportion.
 - CHAPTER III. The Metric System.
 - CHAPTER IV. How to Measure Surfaces and Capacity
 - CHAPTER V. Powers and Involutions—Roots and Evolution.
 - CHAPTER VI. Mathematics for the Manual and Technical Craftsman—Thermometer conversions—Graphs or Curve Plotting—Logarithms—Use of the Slide Rule.
 - CHAPTER VII. Special Mathematics for the Radio Technician.
 - CHAPTER VIII. Commercial Calculations—Interest—Discounts—Short Cut Arithmetic.
 - CHAPTER IX. Weights and Measures—Useful Tables.

ONLY 50¢ POSTPAID

Send Stamps, Cash or Money Order.

Send today for your copy of this indispensable book. It can be carried readily in your pocket. (Size 6 x 9 in.)

TECHNIFAX

1917 S. State St., RC-1042, Chicago, Ill.



VERTICAL ADJUSTABLE Antennas

For Defense and War installations—standard or special designs developed in monel, aluminum and steel. Tell us your requirements or write for Bulletin of standard designs.

Premax Products

DIV. CHISHOLM-RYDER CO., INC.
 4292 Highland Ave. Niagara Falls, N. Y.

OPPORTUNITY AD-LETS

Advertisements in this section cost 15 cents a word for each insertion. Name, address and initials must be included at the above rate. Cash should accompany all classified advertisements unless placed by an accredited advertising agency. No advertisement for less than ten words accepted. Ten percent discount six issues; twenty percent for twelve issues. Objectionable or misleading advertisements not accepted. Advertisements for November, 1942, issue must reach us not later than October 10, 1942.

Radio-Craft • 25 W. B'way • New York, N. Y.

RADIO SERVICEMEN AND EXPERIMENTERS SEND for our giant radio catalogue. Save dollars. United Radio Co., (10001) Newark, N. J.

OUTDATED MAGAZINES, CATALOG 10c. Ciccone's, 863 First Ave., New York, N. Y.

MEMORIZE CODE EASILY WITH COPYRIGHTED KolorKards. New, Practical. Complete—\$1.00. KolorKards, Dept. RC, Bluffton, Ohio.

USED CORRESPONDENCE COURSES AND TECHNICAL Books Bought, Sold, Rented, Catalog Free. Educational Exchange, Hensley, Ala.

DELSCO FILTERSTAT
 Eliminates radio disturbances caused by motors, fans, refrigerators, lights, etc. Protects radio from line voltage surges.
 A REAL NOISE FILTER
 Manufactured By
DELSON RADIO CO.
 2324 Broadway New York City
 • List Price \$7.50 •
 Write for prices. Very large discounts.

Amazing New "WALSCO" STAPLE DRIVER
 for radio men, electricians or anyone doing stapling. Makes wire and cable installations twice as easy—much neater—saves half the time. Wires can be stapled in corners, behind pipes, into moldings—places never accessible with a hammer and ordinary staples. Drives staples even into wall, brick, mortar, etc. Magazine works automatically and holds strips of staples which come in several colors. Ask your jobber for demonstration and catalogue 41-C of all WALSCO PRODUCTS
 or write **WALTER L. SCHOTT CO.**
 5264 W. Pico Boulevard, Los Angeles, California

Inventions Wanted
 Patented or Unpatented
 We have been successfully selling inventions, patented and unpatented, since 1924. Write us, if you have a practical, useful idea for sale.
CHARTERED INSTITUTE OF AMERICAN INVENTORS
 Dept. 109 Barrister Building, Washington, D.C.

WORLD-TIME CLOCK
 The Only Clock for Universal Use Throughout the Entire World!

A REGULAR CLOCK with A.M. and P.M. divided dial

A WORLD-TIME CLOCK instantly indicating time in all 24 zones

INTERNATIONAL CLOCK with A.M. and P.M. 24 hour dial



Here is really the first new clock advancement in 200 years—three clocks in one, a world-time clock. It is revolutionary! It is years ahead! The Sky Pilot WORLD-TIME CLOCK is the only clock destined for use anywhere in the world. For short-wave fans this clock offers great convenience—it is educational and at the same time indicates world time differences. In a few seconds you can determine the correct time in London, Moscow, Hawaii, Tokyo, Buenos Aires, Halifax—anywhere. American made—it is exceptionally easy to operate. It carries a guarantee of ninety days against defects in material or workmanship. In modernistic design, it is made of brushed brass—measures 5 1/2" high by 4 3/4" wide—and has convex crystal.
 Electric (for A.C. 110-120 volts, 60 cycles) \$9.95
 Spring Model \$8.95
 P.P. prepaid in U.S.A.
 Remit by check or money order; register letter if you send cash or unused U.S. postage stamps.
GOLD SHIELD PRODUCTS
 350 Greenwich St. Dept. RC-10 New York City

PATENTS — TRADE MARKS
 Booklet concerning Inventions & Patents Form "Evidence of Conception" with instructions for use and "Schedule of Government and Attorneys Fees"—Free
LANCASTER, ALLWINE & ROMMEL
 Registered Patent Attorneys
 436 Bowen Bldg. Washington, D. C.

MAKING A VOLTMETER READ WATTS
 (Continued from page 22)

The transformer is now mounted on the base of the metal cabinet, and with the female receptacle, the meter and the rubber grommet mounted on the front panel, we are ready to wire the unit. No trouble should be encountered in making the connections if Fig. 1b is followed. When all connections are completed the panel is fastened to the cabinet and the meter is ready for calibration.

Before we start to calibrate this wattmeter it will be necessary for us to construct a load line. See Fig. 1a. This load line consists of four light sockets connected in parallel with a short lead which has a male plug on the end of it. This load is simple to make, and upon completion, the male plug is inserted into the female receptacle of the wattmeter and the operation of calibrating the instrument begun. With the wattmeter plugged into the A.C. screw a 25-watt lamp into one of the light sockets. The wattmeter should now register a reading. With a fine pen point mark the dial face at this point 25 watts.

At any time in the future that we have an occasion to measure the wattage consumption of any electrical device that has a wattage consumption of 25 watts the needle of the meter should come to a stop at the point which you have just calibrated and marked as 25 watts.

Now if we should screw another 25 watt lamp into one of the other sockets, making a total of 50 watts, the meter will register a new reading and this new point on the dial can be marked as 50 watts. If we should add a 50 watt lamp to another socket we would have a total of 100 watts being consumed and this new reading can be marked on the dial as 100 watts. By screwing different sizes of lamps into the sockets various wattages can be obtained and marked on the dial. Undoubtedly you have recognized the fact now that you have marked the dial in accordance with known standards. In the future whenever you make a wattage consumption test on any electrical device you are in reality comparing the wattage consumption of that device with given standards which you have marked on the dial. When the wattmeter is completed I suggest that you try it out on your radio sets, your soldering iron and any other electrical devices that you have on hand.

Do not attempt to measure the wattage consumption of any device that has a larger wattage consumption than the full-scale reading of the wattmeter.

On completing this wattmeter you may find that the reading you desired for full scale reading is not at its correct location on the dial. This can be remedied by juggling the turns of the new winding, of the transformer. If you wish to move your dial readings up scale remove one or two turns from the new winding. On the other hand if you desire to move your dial readings down scale, add one or two turns to the new winding. When adding or subtracting turns to this new winding it is advisable to take a reading of a known standard after each change and in this way you will be successful in getting your full-scale reading at the correct location.

COMPLETION DATE CHANGED
 FM station, W71SB (South Bend Tribune), South Bend, Ind., was granted modification of its construction permit, extending completion date for the period of 6 months from June 25.

Get This Electric Dry Shaver
ABSOLUTELY FREE!



JUST THINK OF IT—you can get absolutely FREE, the useful DRY ELECTRIC SHAVER which is shown at the left. This ELECTRIC DRY SHAVER is sent to you by the publishers with a one-year subscription to RADIO-CRAFT.

Here Are the Features of The ELECTRIC DRY SHAVER

Constructed of metal with attractive red bronze finish. Scientifically constructed to give a perfectly clean shave. 5-foot rubber insulated cord and plug. Constructed to last for many years.

Operates from 110-volt, 60-cycle A.C. electric line. Carries a two-year manufacturer's guarantee. A fine quality, self-sharpening toilet necessity.

Send your subscription to RADIO-CRAFT for One Year (12 issues) and receive absolutely FREE one of these remarkable Electric Dry Shavers. New subscribers are accepted or you may extend your present subscription another twelve months. Mail your remittance of \$2.00 (plus 25c for shipping charges on Shaver) to the publishers. (Canada and foreign \$2.75.) You will receive your DRY ELECTRIC SHAVER immediately by return mail. Use coupon below to enter your subscription.

RADIO-CRAFT
 25 W. B'way., New York, N. Y.

RADIO-CRAFT, 25 W. BROADWAY, New York, N. Y.

Gentlemen: Enclosed find my remittance of \$2.00 for which enter my subscription to RADIO-CRAFT for one year (12 issues). Send me immediately FREE ELECTRIC DRY SHAVER (Canada and foreign \$2.75). In U. S. add only 25c additional to cover shipping charges on Shaver.

New Subscriber Extend Present Subscription

Name

Address

City State

(Send remittance by check, money order or unused U.S. Postage Stamps. Register letter if you send cash or stamps.) RC-1042

OPERATES ON 110-VOLT, 60-CYCLE A.C. LINE

WE SHIP ELECTRIC DRY SHAVER THE SAME DAY YOUR SUBSCRIPTION ORDER IS RECEIVED.

CLIP COUPON AND MAIL

HOW TO MAKE A 2 3/4 x 4" RECEIVER

(Continued from Page 39)

using the lock nut to hold it in place. The wires pass the Bakelite panel through two small holes drilled in the panel. Since the condenser has no knob, I used an old binding post cap, soldering its metal center to the condenser shaft.

The case was assembled from scrap pieces of Bakelite put together by small L angles fastened by screws. Some of these screws had to be removed and replaced by rivets to permit the battery (No. 455 Eveready, 45 volts) to slide into the back of the case.

Although some form of aerial was required for reception, I found a ground connection unnecessary.

Precautions should be taken in wiring the microtubes. A bead to one side of the tube's terminals should be used as a guide for determining the numbering of the wires. The wire nearest the bead is the No. 1 terminal, as can be seen from the illustration, which in addition shows the actual size of the microtube when compared to an average small-sized paper clip.

Two L brackets fastened to the sides of the case serve as "stops" to hold the B battery in place. The battery has snap-on terminals and the wires are electrically connected to the L brackets. Thus the front panel can easily be removed by loosening two 6-32 1/2-inch long screws, which in addition disconnect the B battery for replacement.

The back cover is a thin piece of Bakelite cut to fit snugly so it will snap into place.

LOW CAPACITANCE AC POWER SUPPLIES

(Continued from page 19)

modulation hum. Specific converter and I-F circuit design intended to reduce modulation hum may be carried out to provide tolerable hum levels with these low voltage systems. Economy of copper and steel will result with the use of an auto transformer instead of the primary coupled type providing the two A.C. plate voltages are balanced in phase.

CONCLUSIONS

The utility of multi-sectioned filters in minimizing total capacitance necessary for acceptable hum levels has been demonstrated. This procedure should prove economical in materials at the possible expense of labor and manufacturing costs. An A.C. receiver with pentode output tube may be filtered with (say) 1, 2 and 1 µf of paper capacitors without the use of a filter choke or large speaker field. If electrolytics of small capacitance are developed to meet the material shortage now becoming acute, then comparable capacitance values are likely to prove permissible.

Paper capacitors or extremely low-capacitance electrolytics do not appear feasible for A.C./D.C. operation. Small A.C. receivers of this size may be developed using A.C./D.C. connection of heaters, but a low-voltage transformer to permit full-wave rectification and satisfactory D.C. voltage output. This type of receiver has small economy over the described higher-voltage type and should find utility only in the event electrolytics for A.C./D.C. use are completely curtailed. In the event of partial curtailment, voltage doubling circuits give promise of replacing A.C./D.C. circuits.

—R. C. A. Review.

WHILE THEY LAST

All of the attractive items listed here are brand new. ALL are in PERFECT WORKING ORDER. In many cases, the parts alone total more than the price we are asking. 100% satisfaction guaranteed or your money refunded. ORDER FROM THIS PAGE. Use the convenient coupon below. Include sufficient extra remittance for parcel post charges, also order shipped express, collect. Any excess will be refunded. C.O.D. shipments require 20% deposit. If full remittance accompanies order, deduct 2% discount. Send money order, certified check, new U. S. stamps. No C.O.D. to foreign countries.

ORDER TODAY LIMITED QUANTITIES PROMPT SHIPMENTS ASSURED

HANDY WORKSHOP OUTFIT

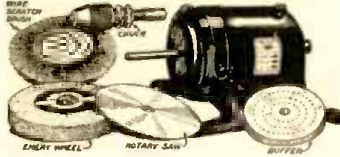

Here is a marvelous article that to the best of our knowledge has never sold at such a low price. This outfit must be seen to be appreciated. It delivers the goods! It comprises a variable speed universal motor for 110 volts A.C. or D.C. Made originally for dictaphone machines by American Gramophone Co. Motor is reconditioned and in excellent condition; all other parts are brand new. Special lever control permits various speeds up to 3000 r.p.m. Measures 7 1/2" x 3 1/4" diam. overall. Included in the outfit are the following items, as illustrated: 1 excellent chuck which takes drills and other tools—chuck is easily screwed to motor shaft; standard emery wheel, 4" diameter; fine steel rotary saw, 1" diameter; wire scratch brush, 4" diameter; standard cloth buffer, 3" diameter. Total Wt. 9 lbs. ITEM NO. 149 Complete outfit, including motor. YOUR PRICE \$5.45

VARIABLE SPEED UNIVERSAL MOTOR

FOR 110 VOLTS, A.C. OR D.C. Made for Dictaphone machines by American Gramophone Co. Used, but in excellent condition. Special lever control permits variable speeds up to 3000 r.p.m. 1/2" shaft extends from both sides. Motor, 7 1/2" x 3 1/4" diam. overall. Stp. Wt. 6 3/4 lbs. ITEM NO. 11 YOUR PRICE \$2.45

WESTON MODEL 562 A.C.-D.C. AMMETER

Designed by Weston for the Eastman Kodak Co. It is a precision-built magnetic-vane type ammeter which, with suitable shunts, can be used as a milliammeter. It is 2" in diameter and designed for panel mounting. Bakelite base and black-enameled cover. Stp. Wt. 2 lbs. ITEM NO. 35 YOUR PRICE \$1.25

POWERFUL ALL-PURPOSE INDUCTION MOTOR IDEAL FOR EXPERIMENTERS—101 USES

Sturdily constructed to Drexelion standards, this self-starting shaded pole A.C. induction motor is powerful enough for a large variety of uses. Some of these are: Automatic Timing Devices, Current Interrupters, Electric Fans, Electric Chimes, Window Displays, Photocell Controls, Electric Vibrators, Small Grinders, Buffers and Polishers, Miniature Pumps, Mechanical Models, Sirens, and other applications. Consumes about 15 watts of power and has a speed of 3,000 r.p.m. When geared down, this sturdy unit will constantly operate an 18-inch turntable loaded with 200 lbs. dead weight—THAT'S POWER! Dimensions, 3" high by 2" wide by 1 3/4" deep; has 4 convenient mounting studs; shaft is 3/16" long by 3/16" diameter, and runs in self-aligning oil-retaining bearings. Designed for 110-20 volts, 50-60 cycles, A.C. only. ITEM NO. 147 YOUR PRICE \$1.45

100 POWER TELESCOPE LENS KIT

Make your own high powered 6 ft. telescope! Now you can thrill to a close-up view of the worlds out in space. See the rings around Saturn, the mountains of the moon! Kit contains 3" diam., 75" focal length, ground and polished objective lens and astronomical eye-piece magnification 50x and 100x. Complete kit with full instructions. ITEM NO. 123 YOUR PRICE \$1.95

WESTERN ELECTRIC BREAST MIKE

This is a fine light-weight aircraft carbon microphone. It weighs only 1 lb. Mike comes with breast-plate mounting and has 2-way swiveling adjustment so that it can be adjusted to any desired position. There are 2 woven straps; one goes around neck, the other around chest. Straps can be snapped on and off quickly by an ingenious arrangement.

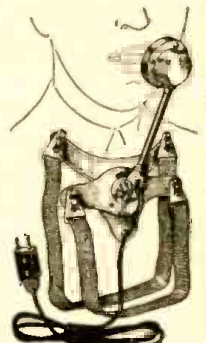

This excellent mike can be adapted for home broadcasting or private communication systems. By dismounting breastplate, it can be used as desk mike. Comes complete with 6-foot cord and hard rubber plug. Finished in shatterproof plate, non-rustable. THIS IS A BRAND NEW MIKE IT HAS NEVER BEEN SOLD AT SUCH A LOW PRICE BEFORE. ORIGINAL LIST PRICE \$15.00. Shipping weight, 2 lbs. ITEM NO. 152 YOUR PRICE \$1.00

METAL CUTTING SAW

Here is an ideal metal-cutting saw made of fine tool steel specially designed to cut metal. Teeth are set at a special double angle for metal-cutting work. Saw is specially hardened for long and extended use; measures 3 1/4" diameter; center hole is 1/2" square; thickness 42/1000 (42 mils.) 3/64". ITEM NO. 151 YOUR PRICE 50c

POWER ADJUSTABLE RHEOSTAT

Here is an excellent rheostat used especially to regulate speeds of small motors such as our Handy Workshop Outfit. This rheostat can be used in connection with motors up to 1/20 h.p. This fine rheostat is wire-wound on porcelain insulation. The black enamel steel casing is perforated for ventilation. Adjustable handle regulates speed of motor easily and smoothly. Size 5" x 2 3/4" overall. Stp. Wt. 2 lbs. ITEM NO. 153 YOUR PRICE \$1.20

AMAZING BLACK LIGHT!!

Powerful 250-Watt Ultra-Violet Source. The best and most practical source of ultra-violet light for general experimental and entertainment use. Makes all fluorescent substances brilliantly luminescent. No transformers of any kind needed. Fits any standard lamp socket. Made with special filter glass permitting only ultra-violet rays to come through. Brings out beautiful opalescent hues in various types of materials. Sweil for amateur parties, plays, etc., to obtain unique lighting effects. Bulb only. Stp. Wt. 1 lb. ITEM NO. 87 YOUR PRICE \$2.00

WATT HOUR METER

Completely overhauled and ready for immediate service. Designed for regular 110-volt, 60 cycle 2-wire A.C. circuit. Servicemen use it in their shops to check current consumption of sets, soldering irons, etc. Keeps costs down. If dismantled, the parts alone would bring the price. The elaborate motor train could be used as a counter on machines of various kinds. Simple to install; 2 wires from the line and 2 wires to the load. Sturdily constructed in heavy metal case. Size: 8 1/4" high, 6 1/4" wide, 5" deep. Westinghouse or General Electric. Stp. Wt. 14 lbs. ITEM NO. 33 YOUR PRICE \$4.95

HUDSON SPECIALTIES CO., 40 West Broadway, N. Y. C.

IT'S EASY TO ORDER—CLIP COUPON—MAIL NOW ORDER FROM THIS PAGE.

HUDSON SPECIALTIES CO., 40 West Broadway, Dept. RC-1042, New York, N. Y. I have circled below the numbers of the items I'm ordering. My full remittance of \$..... (Include shipping charges) is enclosed. OR my deposit of \$..... is enclosed (20% required), ship order C.O.D. for balance. No C.O.D. order for less than \$2.00. (New U. S. stamps, check or money order accepted.) Circle Item No. wanted: 11, 33, 35, 87, 123, 147, 149, 151, 152, 153

Name Address City State

Send remittance by check, stamps or money order; register letter if you send cash or stamps.

TECHNICAL BULLETINS

Technical bulletins give reliable information in easy-to-follow form, and save valuable time otherwise spent in laborious reading of numerous books. Every subject is treated briefly and concisely, yet completely. No complicated mathematics, chemistry, electricity, or theory. Each bulletin is written in simple language.

PRICE \$1.00 EACH POSTPAID
ORDER BY NUMBER

ELECTRICAL DESIGN & CONSTRUCTION

D-111—DESIGNING AND BUILDING TRANSFORMERS.—Simple, non-mathematical methods for designing transformers of all kinds; also special transformers such as are used for ultra-violet lamps, Neon tubes, etc.

D-112—DESIGNING ELECTRO-MAGNETS.—The subject of electro-magnet design is so clearly explained that anyone can design and build magnets for practically every purpose. Complete, practical data covering both A.C. and D.C. magnets.

D-113—HOW TO DESIGN SOLENOIDS AND PLUNKER MAGNETS.—Anyone who is interested in solenoids or Plunker magnets cannot afford to be without this non-mathematical, simple and practical information.

D-101—USING NICHROME RESISTANCE WIRE.—Explains how to repair electric flat irons, toasters, rheostats, resistors and other electric heating devices. Simplified methods of figuring lengths and sizes of wire for any job.

D-106—REWINDING ELECTRIC MOTORS.—Complete information, diagrams, sketches, tables, etc., to enable any shop man, mechanic, electrician, experimenter, etc. to rewind A.C. and D.C. motors and generators of all types.

D-144—A. C. CURRENT CONTROLLED WITH EASILY MADE CHDKE COILS.—How to design and construct choke coils. How to determine size and amount of wire required, how to find the core size. Full details on assembly and coil winding.

D-148—DESIGNING AND USING ELECTRIC RELAYS.—Simple practical instructions for designing, building, and using A.C. and D.C. relays; also thermo-electric relays. Includes practical relay control systems for motors and machinery.

D-127—SMALL ELECTRIC LIGHT PLANTS, DESIGN AND CONSTRUCTION.—Tells how to design and build small electric light plants for cottages, camps or country homes at small cost. Covers construction of a 110-volt system to light six 30-watt lamps, how to build a 6-volt system using an auto-generator with or without a battery, and how to convert a Ford model "T" generator to a 110-volt, A.C. generator.

D-134—ELECTRICAL EXPERIMENTS WITH SIMPLE MATERIALS.—How anyone without previous knowledge of electricity can perform harmless, interesting, and educational experiments with simple, inexpensive materials.

D-131—MODEL MAKERS & INVENTORS GUIDE TO REMOTE-CONTROL SWITCHING.—Controlling electrical devices; train models, equipment of all types at a distance by means of a telephone dial.

D-137—ELECTRICAL METERS EASILY BUILT.—Information that will enable students to build experimental electrical meters to measure alternating or direct currents, including ammeters, voltmeters and wattmeters sufficiently accurate for experimental purposes.

Each Bulletin consists of a set of large sheets, assembled in one packet, size 9 x 14 1/2"; weight 1/4 lb. Numerous illustrations, diagrams, charts to supplement text.

TECHNIFAX

1917 S. STATE ST. (DEPT. 1042) CHICAGO, ILL.

DEPT. 1042

TECHNIFAX 1917 So. State, Chicago, Ill.

Enclosed find \$..... for which please send me postpaid the following Technical Bulletins:

No.

Name

Street and Number

City and State

FACTORS CONTRIBUTING TO GOOD RECORDING

(Continued from page 29)

walls compress, permitting the stylus tip to "short cut" around the peaks of modulation, particularly at the inner diameters of lacquer discs. In the case of pressings, which are a harder medium, the effect is not so pronounced and, consequently, the reproduction of more high frequencies is apparent. However, with the harder pressing, appreciable driving forces are still involved and after a certain number of playings the high-frequency peaks are worn off, with resultant loss of frequency range and an increase in distortion.

This loss of high frequencies is not a constant throughout the disc. The outer circumference of a disc is traveling at a greater relative linear velocity than is the innermost recorded groove. This means that for a given frequency and amplitude, the physical wavelength of the engraved pattern is longer and, consequently, better defined than that of the innermost engraving. The recording and reproducing styli have finite dimensions, so that because of the finite size and the use of the burished edge on the recording stylus mentioned previously, a deterioration of the wave shape takes place toward the central portion of the disc. The loss of high frequencies thus incurred is generally referred to as "translation loss." Strangely enough, there is an opposite effect which occurs under some conditions; that is, the high-frequency response tends to rise with increase in frequency on reproduction over that which was recorded. This effect is encountered at the higher groove velocities and is especially pronounced at the outer diameters of a 78 rpm recording. The reason for this is that the vibratory system of the reproducer and the material in which it is working set up a resonant condition. In the case of relatively soft lacquer, the resonant frequency may well appear within the working range of the system, while with the harder pressings, it may appear beyond the pass band of the system, producing the same effects, but to a lesser degree within the working frequency range.

Figure 6-a shows translation curves for a typical good reproducer and a lacquer disc. The loss of high frequencies toward

the center of the disc is very apparent. The rise of the high frequencies due to resonant conditions at the higher groove velocities may also be seen.

Superior performance has been obtained in specially built reproducers. Such units have been classified as laboratory models. In general, they are extremely light in weight and are sufficiently delicate to cause their use in the commercial transcription field to be somewhat hazardous. With the incorporation of a little more ruggedness in the construction of these laboratory-type reproducers, and with the proper education of the user, it is reasonable to believe that additional advances will take place in the reproducer field in the near future.

Figure 6-b shows the translation losses encountered in a fairly rugged laboratory model reproducer. It is seen to be an improvement over the previous curve.

Figure 7 shows a family of characteristics obtained at various disc diameters. It conveys essentially the same information given in Figure 6-b, but in a more useful form.

The improvement in reproducers lies in the hands of the manufacturers and also is contingent upon the demands imposed by the field. The user can contribute his part at the moment by insisting upon using the best the market has to offer. In any event, if high fidelity is demanded, there is no excuse in transcription work for the use of the heavy reproducer with its massive steel stylus, which was in vogue only a few years ago.

CONCLUSION

The mention of other than a very few specific dimensions has been purposely avoided in this paper. This is to avoid possible confusion, since it is to be expected that the results of the standards committees will be published in the near future.

The use of standardized recording and reproducing techniques by certain organizations has provided excellent operating experience to help in the establishment of what is hoped will be the use of the same standards by all. The use of the same standards and the employment of good engineering practice will permit a coordination between the recording and reproduction of the records with resultant improved performance.

—R.C.A. Review

SPECIAL

ABC OF TELEVISION



Contains latest material on Television developments. It covers theory of scanning; simple television receiver, how the eye sees; the photo-electric cell; neon lamps; need for broad channel width in transmission signals; cathode ray tube and television receivers; Earnsworth system of television transmission, and other important features.

SHORT WAVE GUIDE



Covers hundreds of short-wave questions and answers; illustrates popular short-wave kinks; gives explicit instructions for building simple short-wave receivers. Instruction on the best type of antenna installation; diagram and construction details for building transmitters.

The books listed below have never been sold by us before. The value of each book is 50c. They are exactly the same as **RADIO & TELEVISION'S** 50c blue books which have been on the market for years. For a short time only we are selling these at a special reduced price of only 75c for the 3 books. All of the books contain numerous photographic illustrations and diagrams and have stiff flexible cover.

S. W. RADIO QUIZ BOOK



This book covers questions and answers on transmitters, ultra short-wave receivers, practical kinks, wrinkles and technical hints; data: novel coil winding data; convert hook-ups for experimenters; how to "hook-up" power supplies, modulators, beaters, noise antennas, prososcillators, 5-meter receivers, selectors, 5-meter receivers.

RADIO & TELEVISION
25 W. Broadway,
New York, N. Y.

Gentlemen:
Enclosed you will find remittance for 75c (cash, new U. S. stamps or money order accepted) for which please send me at once your 3 books
ABC OF TELEVISION **SHORT WAVE GUIDE**
SHORT WAVE RADIO QUIZ BOOK

Name

Address

City

State

RC-10-42

FLIGHT RADIO SCHOOL TRAINS ENLISTED MEN

(Continued from page 26)

In another room is a Pan-American student-employee (in uniform) operating a Vibroplex—a semi-automatic transmitting key. He is hooked up on a circuit with similar operators and they are exchanging messages. Other students can be seen transcribing actual airline traffic on their "mills."

A battery of code machines greets us. Creeds and Kleinschmidts—automatic tape-performing machines which can store up traffic that can be fed to a transmitter and out on the air as fast as 180 words a minute. Students are checking messages they received against the tape. Nearby instruction work is being given in teletype "punching," another phase of communications work.

In the Code Room is a novel panel board. Instead of the old-fashioned patch cords, switches are used. By turning a single-gang, 12-position rotary switch, any one of twelve channels may be fed into any single table or any combination of tables, including audio receivers. Through a unique tie-back arrangement the instructor can monitor the progress of any individual student or give instructions right on the circuit without leaving his position at his desk.

The maintenance class, one of the best liked courses, gives the student an opportunity to work on the latest types of ultra-short-wave transmitters and receivers. Modern test equipment is used here. The students adjust, repair, replace parts and go through the whole gamut of emergency repair of modern airline equipment.

Passing along the corridor, some strange sounds were heard which seemed to be coming from behind a closed door. Inquiry brought the information that the sounds were the real and reproduced voices of students being trained in voice culture and diction. The instructor was recording the students' voices for criticism.

SIGNAL CORPS TRAINING BEGUN AT ILLINOIS TECH

(Continued from page 27)

"several thousand." Most of the courses are of either a 10- or 12-week duration, allowing four or five complete turnovers annually.

Like the courses of study themselves, laboratory equipment—which is now valued at a minimum of \$100,000—had to be designed and built largely by Illinois Tech engineers, since much of the apparatus needed was too new in principle to be manufactured by standard electrical companies.

Apparatus built at Illinois Tech includes numerous wave guide facilities, designed especially for use with the micro-waves; Lecher-wire systems for the measurement of wave lengths; coupling and tuning units, and numerous types of tube equipment. Most of the equipment consists of new adaptations of older principles modified for use with the ultra-high frequencies.

Also included in the laboratory equipment are the complete facilities of the old RCA Institute in Chicago, acquired by Illinois Tech in June and now set up with other equipment to form one of the most complete electronics laboratories available anywhere. The RCA facilities include some of the finest equipment available for work in radio, electronics, code and television, direction finders and eleven standard transmitters ranging from tiny 15-watt stations to the largest commercial types.



"THE INDUCTANCE AUTHORITY"

By EDWARD M. SHIEPE, B.S., M.E.E. [A NEW BOOK]

THE ONLY BOOK OF ITS KIND IN THE WORLD, "The Inductance Authority" entirely dispenses with any and all computation for the construction of solenoid coils for tuning with variable or fixed condensers of any capacity, covering from ultra frequencies to the borderline of audio frequencies. All one has to do is read the charts. Accuracy to 1 per cent may be attained. It is the first time that any system dispensing with calculations and correction factors has been presented.

There are thirty-eight charts, of which thirty-six cover the numbers of turns and inductive results for the various wire sizes used in commercial practice (Nos. 14 to 32), as well as the different types of covering (single silk, cotton-double silk, double cotton and enamel) and diameters of $\frac{1}{8}$, $\frac{1}{4}$, $1\frac{1}{4}$, $1\frac{1}{2}$, $1\frac{3}{4}$, 2 , $2\frac{1}{4}$, $2\frac{1}{2}$, $2\frac{3}{4}$ and 3 inches.

Each turns chart for a given wire has a separate curve for each of the thirteen form diameters.

The book contains all the necessary information to give the final word on coil construction to service men engaged in replacement work, home experimenters, short-wave enthusiasts, amateurs, engineers, teachers, students, etc.

There are ten pages of textual discussion by Mr. Shiepe, graduate of the Massachusetts Institute of Technology and of the Polytechnic Institute of Brooklyn, in which the considerations for accuracy in attaining inductive values are set forth.

The book has a flexible fiber black cover, the page size is 9 x 12 inches and the legibility of all curves (black lines on white field) is excellent.

Price at your dealer or direct—\$2.50

GOLD SHIELD PRODUCTS

350 Greenwich St. (Dept. RC10)
New York City

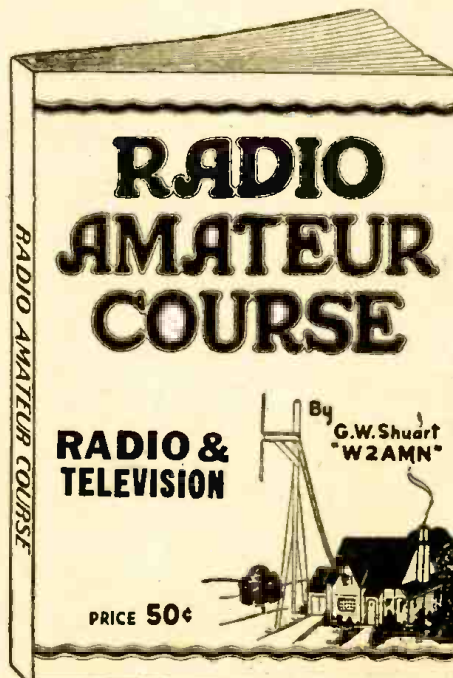

RADIO & TELEVISION

By G.W. Shuart "W2AMN"

PRICE 50¢

148 PAGES

6 x 9 INCHES

OVER 150 RADIO DIAGRAMS and TECHNICAL PHOTOGRAPHS

RADIO AND TELEVISION

25 West Broadway New York, N. Y.

SERVICEMEN! Get This Handy New RADIO CHEMICAL LABORATORY



SAVES TIME — MONEY — TROUBLE Repair Old Parts with Chemicals

A real professional outfit! Contains every essential radio chemical and cement—everything you need for instant service on speakers, coils, contacts, dials, volume controls, cabinets, etc. Permanent indexed rack for easy use on bench or wall. Every efficient radio man should have this complete Laboratory.

Contains 20 Most Needed Radio Cements and Chemicals. Twenty large 2 oz. bottles contain cements, solvents, contact cleaners, non-slip dial chemicals, lubricants, insulating varnish, cabinet stains, glue, liquid dope, grafoline, etc. etc. Use it a week and you'll wonder how you ever got along without it. Get one today! Dealer net cost only \$4.99 with FREE RACK. ORDER FROM YOUR RADIO JOBBER



GENERAL CEMENT MFG. CO. Rockford, Illinois, U.S.A.

Your Money Back—

If the RADIO AMATEUR COURSE does not represent the greatest book value ever offered to the radio "fans" for **50¢**

To convince you that there isn't a better book buy today, the publishers of the RADIO AMATEUR COURSE make the sensational offer of a money-back guarantee on such a low-priced book. Stop in at any of the many dealers handling this book and examine it. See for yourself if the RADIO AMATEUR COURSE isn't just the book you've always wanted.

Printed on the finest coated paper—well illustrated attractive 4-color cover—complete with radio information you must have. It contains a step-by-step program for obtaining a short-wave radio education.

Written by George W. Shuart, W2AMN
Foremost short-wave authority

RADIO AND TELEVISION
25 West Broadway, New York, N. Y.

Gentlemen: I enclose herewith my remittance of Fifty Cents (50¢) for which please send me POSTPAID, my copy of the RADIO AMATEUR COURSE. (Remit by check or money order; register letter if you send cash or unused U. S. Postage stamps.)

Name

Address

City State RC-1042

•SERVICING•

MELVILLE-TRAINED MEN ARE "POUNDING BRASS" FOR VICTORY

Behind communications equipment of every type—Government and Commercial—hundreds of Melville-trained radio operators and technicians throughout the world are busy day and night, doing their part for Victory. And when peace comes, many of these men will continue the climb to greater engineering responsibilities.

On the land, on and under the sea, in the air—everywhere radio equipment must be operated with speed, precision, and courage—there you find men who began their radio careers at Melville Aeronautical Radio School. Their outstanding performance is the reason why so many leading airlines of the world look to Melville for new men—why the Army, Navy, Merchant Marine and Coast Guard seek the cooperation they are getting from Melville for the instruction of young men from all parts of America. The management of this school is proud of every Melville graduate who is now "doing his stuff" in the service of the United Nations and in Commercial radio aboard the ships and planes of the world.

MELVILLE

AERONAUTICAL RADIO SCHOOL, INC.

45 West 45th St. New York City

Training Men for Radio in the Service of
AIRLINES-ARMY-NAVY-MERCHANT MARINE-COAST GUARD-INDUSTRY



4 STANDARD TYPES

of Amperite Regulators replace over 400 types of AC-DC Ballast Tubes now in use.

Amperites are real REGULATORS... have patented Automatic Starting Resistor which prevents initial surge and saves pilot lights... Ask Your Jobber.

AMPERITE

THE *Simplest* WAY TO REPLACE BALLASTS

WRITE FOR REPLACEMENT CHART

AMPERITE CO. 561 BROADWAY, NEW YORK, N. Y.

ANALYSIS AND ALTERATION OF AN ANALYZER

(Continued from page 13)

leg. Since the 262.787-ohm leg is in parallel with the meter-resistance leg, then a drop of .25 volts must be across it. Therefore, a current of .0009513 amps must flow in this 262.787-ohm leg, since .25 volts divided by 262.787 ohms equals .0009513 amps. Since 50 μ a. already is flowing in the meter leg, the total analyzer current flowing for the 1 ma range is .001013 amps, an error of about 1.3%, assuming that the elementary circuit analysis is generally correct and ignoring various averaging and compensating factors in the analyzer. A simple chart can be set for the D.-C. current ranges.

With the aid of a chart and Ohm's law, some additional ranges can be calculated. Remembering that the total resistance loop must remain constant at 5262.787 ohms and resorting to some simple algebra, we can calculate for the required values for a 500-ma range, for instance. We would have to discard the .773-ohm resistor between the 250 ma. and 1 ma. ranges and substitute two resistors equal to .773 ohms. In other words we would have to tap the .773 ohm resistor at an appropriate value to get the 500-ma. range, as in the case of the volt ranges. Setting up the analyzer current circuit with these two substitute resistors in place of the .773-ohm unit, we can call one x ohms and the other $.773-x$ ohms. Thus we have a total of $.262+x$ ohms in one shunt leg and a total of $5262.525-x$ ohms in the meter-shunt leg. We know that at full-scale deflection we have 50 μ a. flowing in the meter-shunt leg, or a voltage drop of $(.262+x) \times .00005$ volts. Since we are creating a 500-ma. range, we must have a total analyzer current of 500 ma. at full scale deflection. Since we already have .00005 in the meter leg, then a current of $.5-.00005$ or .49995 amp. flows in the other shunt leg. Therefore we have a voltage drop of $[(.262+x) \times .49995]$ volts in this shunt leg or $(.1309738-.49995x)$ volts. Since these two legs are in shunt, the voltage drops across them must be equal and therefore we can equate the two quantities representing the voltage drops and we get the following:

$$\begin{aligned} .1309 + .4999x &= .2631 - .00005x \\ .49995x &= .1322 \\ x &= .264 \text{ ohms} \\ .773 - x &= .509 \text{ ohms} \\ \text{Check } -.264 + .509 &= .773 \text{ ohms} \end{aligned}$$

Therefore we replace the .773-ohm resistor with the two equivalent .264- and .509-ohm units to get the extra 500-ma. range. In other words, since the 500-ma. range is about one third the way between the 250 and 1,000 ma. (1 amp.) range, by tapping the .773-ohm resistor about one third the way down (at .264 ohms) we obtain the new 500-ma. range. Similarly, we can calculate for any other current range within the 100- μ a. and 10-amp. range limits of the analyzer.

When we get to the ohmmeter ranges, we get into more complications. (See Fig. 5). This rather elaborate circuit is no doubt familiar to test-circuit and insulation-test workers. The circuit has been rearranged and simplified somewhat.

A chart of resistor values for these ranges can be set up but is not of much value where a full understanding of alteration or addition to these circuits is concerned. A further complication lies in the fact that the actual voltage of the battery

used is an unknown under actual operating conditions since it depends upon the make, age and loading of the particular unit being used. Therefore, the variable zero-setting resistor's setting is an unknown and must be determined in one way or another. This is the 15,000 ohm wire-wound potentiometer).

Figure 6A shows the R-times-10 range rearranged still further to simplify calculation for full-scale meter deflection when the resistance under test is zero. This is to obtain the value of the variable zero-set potentiometer when the battery voltage is

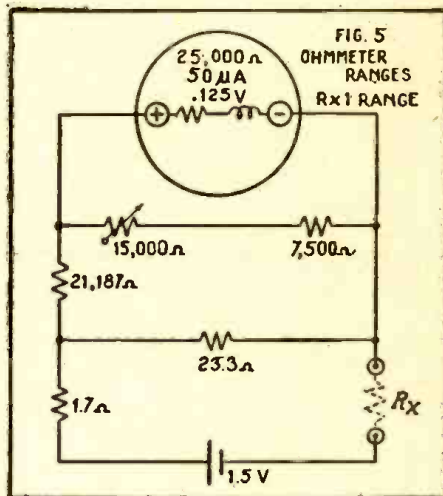

assumed to be its full 1.5 volts. Fig. 6B is arranged for a test resistor of 1,000 ohms (one tenth of one per cent) which gives a meter current of 10 μ a, since the 100 marking on the ohmmeter scale coincides with the 10 marking on the volts-mils scale. In

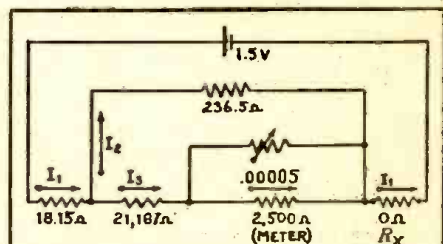

FIG. 6A. Rx10 RANGE REARRANGED FOR CALCULATING VALUE OF ZERO-SET RESISTOR WHEN BATTERY IS AT MAXIMUM 1.5 VOLTS AND TEST RESISTOR IS ZERO OHMS. METER DEFLECTION IS FULL-SCALE AT 50 μ A WITH ZERO-SET RESISTOR ADJUSTED (KIRCHOFF'S LAWS ARE APPLIED IN THIS CASE)

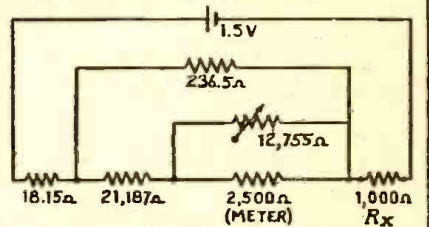

FIG. 6B. Rx10 RANGE SET UP TO CHECK TEST ON 10 μ A AND 100-SCALE MARKINGS ON A 1,000 Ω TEST RESISTOR. OHM'S LAW IS APPLIED IN THIS CASE.

the former case we use Kirchoff's laws and in the latter case we may use Ohm's law and the parallel-resistance formula.

The use of Kirchoff's laws are advisable here since the circuit in 6A is a bit too in-

(Continued on page 62)

OFF THE PRESS!

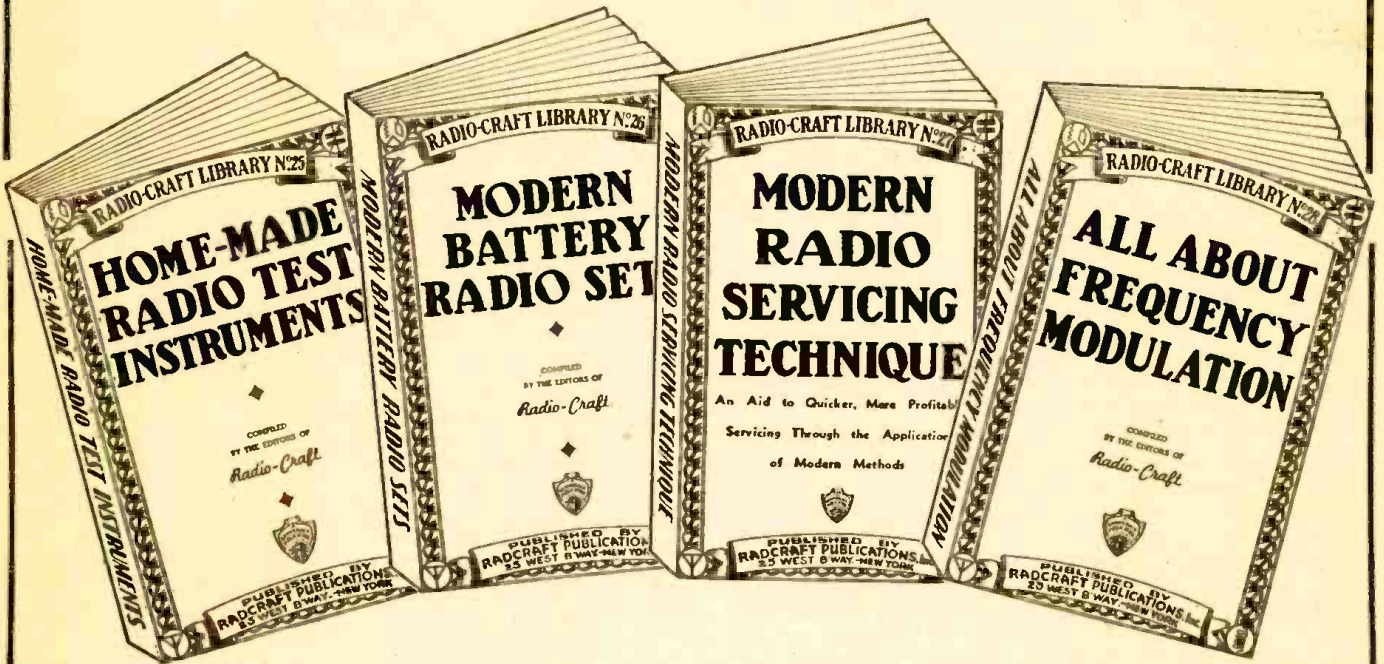

New RADIO-CRAFT Library Books

THE four latest books of our well-known RADIO-CRAFT Red Books—Nos. 25, 26, 27 and 28—have just come off the press. These four books are all on timely subjects and we recommend every one of them to you strongly.

Now, more than ever, radio education has become a burning question. If you are to be in the National Service; in the Army, Navy or Air Force—practical radio knowledge is of paramount importance. **YOU CAN GET BETTER RATINGS AND ADVANCE QUICKER IF YOU HAVE A GOOD RADIO BACKGROUND.**

Conversely, if you are not with the armed forces, there is a whale of a job to be done at home. With more and more men going into the service, the demand for practical servicemen becomes greater each day. Therefore we say: **PROFIT BY THESE UNIQUE BOOKS, WHICH ARE PRICED SO LOW THAT THEY ARE WITHIN THE REACH OF EVERYONE'S PURSE.**

No. 25—HOME-MADE RADIO TEST INSTRUMENTS

This book includes articles covering a wide range of test apparatus of live interest to every radio man. Servicemen will find many circuits in this book to make their work more profitable. New ideas in test equipment make it possible to service radio receivers more quickly.

Laboratory workers and experimenters will find many articles which describe in detail construction and use of all essential radio test units—multi-meters, oscillators, stage-analysis testers, oscilloscope equipment, V. T. voltmeters, etc. Even advanced technicians will be interested in the circuit arrangements showing the new and improved variations of well-known, basic test equipment. A MUST for every serviceman. This book contains 86 illustrations.

Outline of Contents: A Low-Cost Signal Chaser—Signal Tracer Test Unit—Simplified Practical Signal Tracer—A Home-Made Infinite-Resistance Tube Checker—Build This Direct-Reading V.-T. Voltmeter—How to Make a Modern V.-T. Voltmeter—Measuring High Values of A.C. Voltage and Current With a Low-Range Meter—How to Make a Meter-Range Extender—How to Build a Practical Tube Tester and Set-Analyzer Adapter—The Beginners' Simple Volt-Milliammeter—Build This Simplified Neon-Type Test Unit—Midget Oscilloscope—How to Make and Use a Frequency Wobbler—Double Tracing Your Oscilloscope—Home-Made Frequency Modulator.

No. 26—MODERN BATTERY RADIO SETS

Whether you are a radio man or a beginner, the articles in this book give you basic circuit arrangements or elementary radio receivers which serve the dual role of teaching the elements of radio reception, as well as making perfectly-operating 1- and 2-tube radio receivers. Picture diagrams and bread-board layouts follow.

Advanced radio set builders are offered more complicated arrangements. Laboratory workers and engineers will find in many of the articles circuit and constructional features which have become commercial practice. Many entirely new ideas are given in this book. One of the most important volumes we recently issued. This book contains 76 illustrations.

Outline of Contents: Beginner's 1-Tube High-Gain All-Wave Receiver—Beginners-Build This 1-Tube Loop Receiver—A "3-in-1" Battery Portable—An Easily-Built "Howling" Superregenerative 2-In-1 "Card File" Battery Set—A 2-Tube Superhet With Pentagrid Regenerative 2nd-Detector—The 4-Tube Superhet Vacation Portable—The "Lunchbox 5" Battery Portable—"The Seafarer" Loop-Type Boat Radio Set—4-Tube Permeability Portable—An All-Purpose Portable—A Typical Commercial 3-Way Portable (Pilot Models X-1452 and X-1453)—Switch for Varying "C" Bias on Battery Radio Sets—Making a Simple Portable Aerial—Making a Pilot-Light Fuse—Old Auto Sets for New Cars—Using a Loop Portable in Cars—Quasi-Electric Soldering Iron—Lamp Bulbs as Resistors.

No. 27—MODERN RADIO SERVICING TECHNIQUE

Here is a book of great importance to every radio man, every radio engineer, and particularly all radio servicemen. A list of the contents which follows shows the importance of this book, literally jam-packed with over-flowing with radio meat. Whether you are a servicing beginner or whether you are an experienced serviceman—you will find many important helps in this volume.

Book is eminently practical and will solve many problems for you. More important: It will show you many short-cuts, all calculated to save your time and patience. Practical everyday data on standard receivers appears throughout the book. A whale of a book compressed into a minimum of space. Contains 98 important illustrations.

Outline of Contents: Elementary Servicing Technique—Correct Procedure for the Servicing Beginner—Elementary Procedure for Servicing Radio Sets—A.F.C. Alignment Made Easy—Dynamic Servicing—Dynamic Testing Simplifies Servicing—Modern Receiver Test Requirements—Servicing Universal A.C.-D.C. Receivers—Servicing "Orphans" and Private-Brand Sets—Emergency Servicing Without Test Meters—Servicing Coils—Servicing R.F. Coils—Servicing Oscillator Coils—General Information—RMA Transformer Color Code—What Causes Echo, Fading—Radio Service Puzzlers.

No. 28—ALL ABOUT FREQUENCY MODULATION

Here is a complete compilation of pertinent data on the entire subject of the new coming art of Frequency Modulation.

There is no question but that Frequency Modulation is already revolutionizing radio broadcasting in this country. Were it not for the war, there would now be a tremendous boom in this new art—yet, even with war restrictions imposed upon it, Frequency Modulation is still jumping ahead by leaps and bounds.

With Frequency Modulation no longer a theory—with hundreds of stations already dotting the land and with countless hundreds of others to come when peace is achieved, once more—every radio man should read up and know all there is to know on this most important subject.

This particular handbook is chock-full with a tremendous amount of information which you probably will not find in any similar book in print.

Outline of Contents: The ABC of F.M.—Frequency vs. Amplitude Modulation—Basic Facts About F.M. Broadcasting—Construction—Build This Practical F.M. Adapter—Audio Amplification—F.M. Audio Amplifier, Part 1—F.M. Audio Amplifier, Part 2—F.M. Audio Amplifier, Part 3—F.M. Service—Part 1, Antenna Installation and Service—Part 2, Receiver Alignment and Diagnosis—Part 3, Test Equipment for F.M. Servicing, Engineering—Part 1, The How and Why of F.M.—Part 2, The How and Why of F.M.—Theory and Design Considerations of R.F. and I.F. Coils in F.M. Receivers.

SPECIAL SEND-NO-MONEY OFFER

It is not necessary that you send money with order. If you wish to take advantage of our C.O.D. plan, simply cut out the coupon, paste it on a post card and send it to us. Books will be sent to you immediately.

All four books are listed uniformly at 50c each. No discount on less than three books.

If you wish to take advantage of our special offer, ordering three books or more, we make an unusual low price to you as follows:

3 books—\$1.25
4 books—\$1.50

Do not fail to send coupon today!

RADIO-CRAFT PUBLICATIONS, INC.
25 West Broadway, New York, N. Y.

Radio-Craft Publications, Inc.,		1042
25 West Broadway,		
New York, N. Y.		
Gentlemen:		
Rush to me by return mail, as per your special offer, the following books: (Check books selected.)		
<input type="checkbox"/>	No. 25—HOME-MADE RADIO TEST INSTRUMENTS.	
<input type="checkbox"/>	No. 26—MODERN BATTERY RADIO SETS.	
<input type="checkbox"/>	No. 27—MODERN RADIO SERVICING TECHNIQUE.	
<input type="checkbox"/>	No. 28—ALL ABOUT FREQUENCY MODULATION.	
I will pay postman \$1.00 (if two books are ordered) plus a few cents postage and charges, \$1.25 for three books, plus a few cents postage and charges, \$1.50 for four books, plus a few cents postage and charges. WE CANNOT SEND A SINGLE 50c BOOK C.O.D.		
NAME		
ADDRESS		
CITY STATE		
<input type="checkbox"/> Save shipping and C.O.D. charges! Check here if you send cash with order. (Cash, U.S. new postage stamps, money order, check.) Foreign countries no C.O.D. Add 20% to all prices quoted.		

Radio Patents Digest

Antenna Rotator

No. 2,284,672 issued to Bernard J. Merkle, Chicago, Ill.

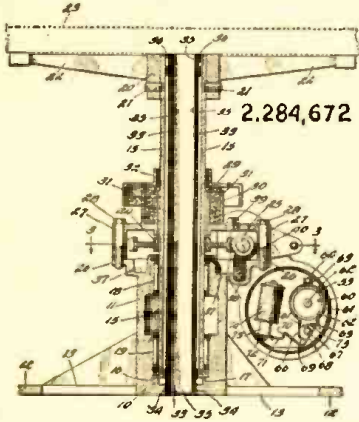

In a rotatable support, a hollow vertical shell with a support at the top, a base into which the lower end of the shell is inserted, bearing means for supporting the lower end of the shell comprising a circular shoulder extending inwardly below the end of the shell, an anti-friction ring bearing interposed between the shell and shoulder, and an oil retaining sleeve secured to the inside of the shoulder and extending upwardly above the bearing within the shell, and means for rotating the shell in either direction.

Electric Phonograph

No. 2,284,678 issued to Lucius P. Petruschell, Stratford, Conn.

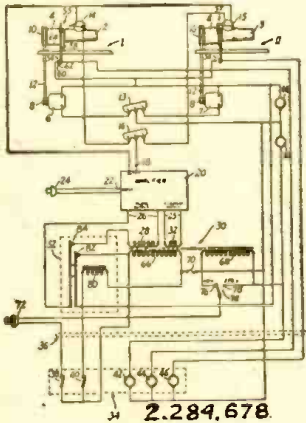

In an electric phonograph, in combination, a plurality of record supporting units each having a translating device mounted for traversing movement in relation thereto, driving means for each of said units, means adapted to effect sequential operation of said units, an electrical power supply for said driving means, control means for controlling the supply of power to said driving means, a plurality of indicating devices connected with said power supply and located with said control means remotely from said phonograph and adapted to indicate which of said phonograph units has been in operation, switch means for controlling the operation of each of said indicating devices, and operating mechanism for each of said switch means operatively associated with one of said translating devices and adapted to actuate said switch means when the respective translating devices occupies an initial position from which it moves during its traversing movement whereby said indicating devices are rendered inoperative when said translating devices are in their initial positions and rendered operative when the translating devices have departed from their initial positions.

Arrangement for the Transmission of Intelligence

No. 2,284,706 issued to Alfred Wiessner and Wolfgang Hagen, Berlin, Germany.

A two-way carrier frequency station in which a plurality of different signal messages are transmitted and received by use of doubly modulated carrier channels, the signal messages being transmitted on different respective frequencies as single sidebands, the transmitting branch comprising a single carrier wave generator, a plurality of first modulators, means for applying to each of said first modulators carrier waves from said single generator and signal waves constituting one of said plurality of different signal messages, means for selecting a single sideband from the output of each of said first modulators, means for deriving higher frequencies from said carrier wave generator, a plurality of second modulators, means for applying to each of said second modulators one of said derived higher frequencies and modulated energy comprising a single sideband selected from the output of a different first modulator, means for selecting a single sideband from the output of each of said second modulators, and

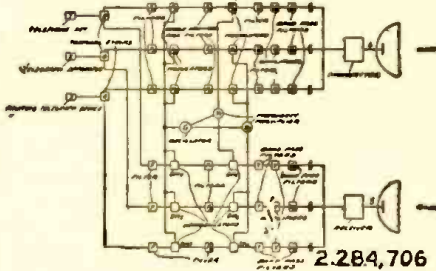

a common transmitter for transmitting said selected single sidebands, and the receiving branch comprising a common receiver for receiving a plurality of single sideband waves, means for segregating said received single sideband waves, first demodulators for said received sidebands, means for applying said derived higher frequencies to said first demodulators, second demodulators and means for applying energy from said single generator and from said first demodulators to said second demodulators to derive the received signal messages therefrom, the modulated energy applied to said second modulators and the modulated energy applied to said second demodulators occupying the same frequency bands.

Television System

No. 2,284,714 issued to Alda V. Bedford, Collingswood, N. J.

In a picture transmitting system, the method of synchronizing scanning at the receiver with scanning at the transmitter which comprises transmitting one group of synchronizing impulses each having a steep front side and having a gradually sloping back side and transmitting another group of synchronizing impulses each having a steep back side and a gradually sloping

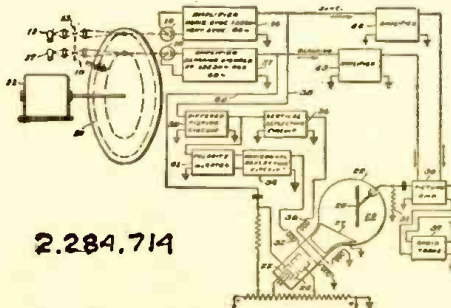

front side, intercepting said impulses at the receiver and substantially differentiating them, and utilizing the differentiated signals for synchronizing the scanning at the receiver.

Electron Discharge Device

No. 2,284,733 issued to Andrew V. Haeff, East Orange, N. J.

An electron discharge tube including means for projecting a beam of electrons, means for modulating said beam of electrons, an accelerating electrode for said beam of electrons and a collecting electrode for collecting the electrons after their passage past said accelerating electrode, all said means being in said tube in the

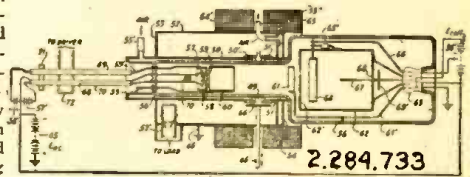

order named, said collecting electrode comprising an elongated cup-shaped member with its open end in position to receive the beam of electrons, and a ring-like electrode within said cup-shaped member and adjacent the open end thereof for providing a field at a lower potential than that of said collecting electrode.

Sound Recording

No. 2,284,744 issued to Edward W. Kellogg, Moorestown, N. J.

The signal recording method which comprises actuating a recording element in accordance with said signals to effect movement thereof corresponding to said signals, and simultaneously causing said element to be displaced from its normal movement by an amount proportional to the slope of the curve being recorded.

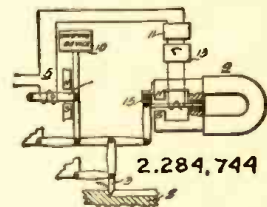

Amplifier Circuits

No. 2,284,855 issued to Julian M. West, Ridge-wood, N. J.

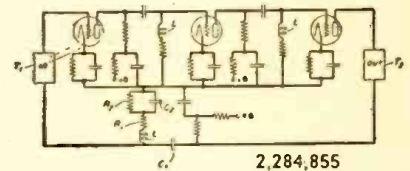

A wave amplifying system comprising a plurality of vacuum tube amplifying devices, impedance networks coupling said devices in tandem, a feedback path coupling the output circuit of the last of said tandem connected devices with the input circuit of the first of said devices, and an impedance network included in said feedback path, said impedance networks each comprising a plate circuit branch and a grid circuit branch, said networks having a combined attenuation which is substantially constant and small relative to the combined gain of said amplifying devices at frequencies in an assigned operating range, which increases with the decrease of frequency just below said operating range, and which has a progressively changing phase as the frequency is still further lowered, means for delaying the building up of phase shift with decreasing frequencies, said means comprising capacitance shunting a portion of the grid circuit branch of one of said coupling impedances, the magnitude of the capacitance being such as to delay the building up of phase shift with decreasing frequencies until a frequency-level is reached at which the net gain around the feedback loop is less than unity.

Navigation Aiding Radio Beacon System

No. 2,284,873 issued to Roland John Kemp, Chelmsford, England.

A navigation aiding radio beacon transmitter installation of the television type comprising means for radiating alternately and periodically two radiations representable by similar but oppositely disposed intersecting polar diagrams which together produce an equi-signal zone along the line of intersection, the rate of alternation of said diagrams being above the rate of persistence of vision, means for rotating the alternated diagrams about the transmitter, picture modulating means for modulating the radiations corresponding to both diagrams with picture signals corresponding to a scanned picture indicative of the momentary direction of the equi-signal zone, means for also modulating said radiations with scanning line synchronising impulses and means for also modulating the radiation corresponding to one of said diagrams with a framing synchronising signal so that a framing synchronising signal is included with the signals sent out on one but not on the other of the two diagrams.

Electric Wave Amplifier

No. 2,284,894 issued to Michael J. Burger, South Ozone Park, N. Y.

A push-pull amplifier, a driver amplifier for supplying oscillations to one side of said push-pull amplifier and having circuit elements of such constants as to produce a definite ratio of even order distortion products to the fundamental of the applied oscillations, an inverter amplifier having an input connected to the output of said driver amplifier and an output connected to the other side of said push-pull amplifier and having circuit elements of such constants as to produce even order distortion products of the applied oscillations of such magnitude and phase as to substantially neutralize the even order distortion products supplied by said driver amplifier to said push-pull amplifier.

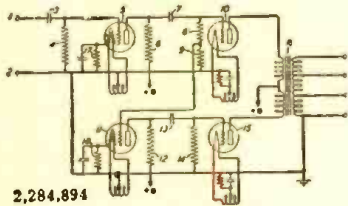

2,284,894

Piezoelectric Crystal Apparatus

No. 2,284,968 issued to John M. Wolfskill, Erie, Pa.

Piezo electric crystal apparatus, comprising: a piezo electric crystal having a pair of major faces, electrodes for said major faces, one of said electrodes being adjustable with respect to the corresponding one of said faces to provide an air-gap therebetween, and means for substantially preventing the movement of said crystal toward or away from at least one of said electrodes during vibration of the apparatus, said means comprising adjustable members extending to and almost touching face portions of said crystal to define and substantially prevent movement of said crystal toward or away from the aforesaid electrode but not affect operation thereof.

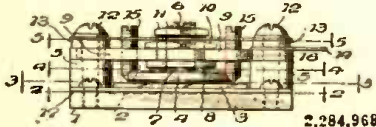

2,284,968

Receiving System

No. 2,285,030 issued to Johan Haantjes, Adelbert van Weel, Maximilian Julius Otto Strutt, and Aldert van der Ziel, Eindhoven, Netherlands.

A frequency changing circuit for heterodyning and separating two signal-modulated carriers of different frequencies, comprising an electron discharge tube having at least a main cathode, a control grid, an auxiliary cathode in the form of a solid plate impervious to electrons adapted upon impact of electrons from the main cathode

to emit secondary electrons, and an anode, means for simultaneously impressing both carrier frequencies upon the control grid, a local oscillator

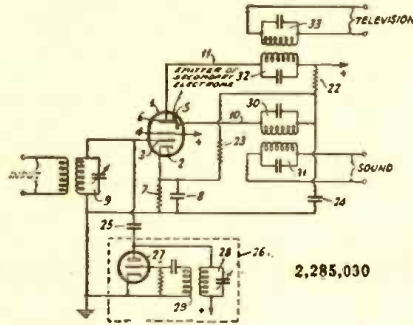

2,285,030

loosely coupled to the control grid for impressing a heterodyne frequency thereon, and a pair of impedances each included respectively in the circuit of the auxiliary cathode and in that of the anode and each having respectively a high value for one of the intermediate frequencies resulting from the interaction between the heterodyne frequency and each of the signal-modulated carrier frequencies.

Combination Electric Musical Instrument

No. 2,285,132 issued to Paul Weathers, Audubon, and William L. Rothenberger, Merchantville, N. J.

In an electric piano, acoustical electric translating means, an audio amplifier connected to said translating means, a loudspeaker connected to said amplifier, manually controlled means independent of the piano mechanism for regulating the volume from all of said translating means, and pedal control means independent of the piano mechanism and supplemental to said manually controlled means for regulating the volume from all of said translating means over the range between the maximum for which the manual volume control is set to the maximum output of said translating means.

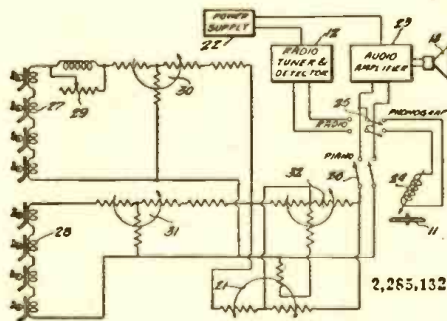

2,285,132

Television System and Method

No. 2,289,363 issued to John N. M. Howells, Kittery, Maine.

A unitary scanning cell adapted to be mechanically moved for scanning, said cell comprising a plurality of closely spaced linearly aligned electrically insulated elemental photo-responsive areas and a plurality of laminar electrical means, each having a characteristic frequency, each of said areas having a different laminar means electrically associated therewith, said laminar means being so connected that the number of external leads

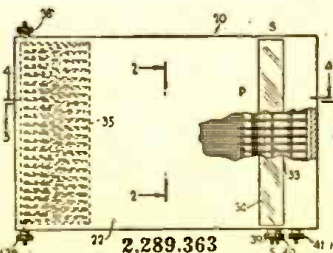

2,289,363

NOW!

You can get the math you need for solving everyday radio and electrical problems



Radiomen and electricians know that the language and the habit of mathematics are essential for real progress in their chosen field. They know mathematics is a tool that they are helpless without.

NOW out of the U.S. Navy Radio Materiel School at the Naval Research Laboratory comes a complete home-study book that is so thorough and so detailed that any reader "who can perform arithmetical computations rapidly and accurately is capable of mastering the principles laid down in this text."

MATHEMATICS for ELECTRICIANS and RADIOMEN

By N. M. COOKE, Chief Radio Electrician, U. S. Navy

604 pages 6 x 9, \$4.00

This book teaches you mathematics from elementary algebra through quadratic equations, logarithms, trigonometry, plane vectors and elementary vector algebra with direct applications to electrical and radio problems. It teaches you how to apply this mathematical knowledge in the solutions of radio and circuit problems. In other words, it gives you the grasp of mathematics you need and then shows you how to use your knowledge. Based on over 8 years' experience teaching mathematics to U.S. Navy electricians and radio operators, the book gives you 600 illustrative problems worked out in detail and over 3000 practice problems with answers so you can check your work.

10 DAYS' FREE EXAMINATION

McGraw-Hill Book Co., 330 W. 42nd St., New York

Send me Cooke's Mathematics for Electricians and Radiomen for 10 days' examination on approval. In 10 days I will send you \$4.00 plus few cents postage, or return book postpaid. (We pay postage if remittance accompanies order.)

Name
 Address
 City and State
 Position
 Company RC-10-42

taken from said cell for placing all of said means in an electrical television scanning circuit is no greater than the number of leads required to place one of said laminar means in said circuit.

Radio Vision Transmitting, Recording, and Reproducing Apparatus and Method

No. 2,289,427 issued to Karl Robert Hoyt, Los Angeles, Calif.

In a system of the class set forth, light beam controlling means including a source of light, a cylindrically bored shell part having a light slot through its bore wall and a barrel part movably fitting in and close to the shell and having in its cylinder wall a series of light slots; the shell and

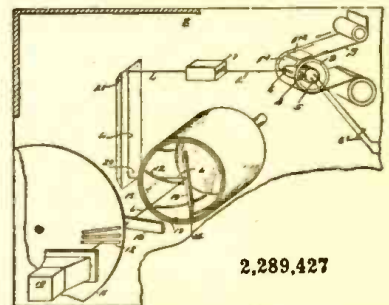

2,289,427

the barrel being relatively movable and the slots of one part being angular as to the slot of the other and cooperating therewith to form a traveling light aperture for light from said source to the exterior of the shell.

Lowest Priced Publications for Experimenters

10 FOR 50c

Here is a large number of radio, short-wave, and mechanical "how-to-make-it" designs. Each is a special publication originated by masters in their respective fields. For the low price of 50 CENTS, you buy TEN complete pamphlets with photographic reproductions, complete mechanical layout, and full description to make it possible for anyone to build the project in question.

PLEASE ORDER EACH PROJECT BY ITS PUBLICATION NUMBER, and use the special coupon below. We accept money-orders, cash, checks or new U. S. stamps. (No foreign stamps.) If you send cash or stamps, register your letter. Money refunded if you are not satisfied. ANY TWENTY-FOUR PUBLICATIONS FOR ONE DOLLAR.

SHORT-WAVE RECEIVER PUBLICATIONS

- HOW TO MAKE THE "OSCILLODYNE" I-TUBE WONDER SET. No. 101
- HOW TO MAKE THE "49" TWIN-PLEX (ONE TUBE PERFORMS AS TWO) RECEIVER. No. 102
- HOW TO MAKE THE WIZARD. I-TUBE 50-WATT TRANSMITTER. No. 103
- HOW TO MAKE THE IMPROVED 3-TUBE DOERLE SET FOR BATTERY OPERATION. No. 104
- HOW TO MAKE THE "GO-GET-EM 2" RECEIVER FOR THE BEGINNER. No. 105
- HOW TO MAKE THE I-TUBE-ALL-ELECTRIC OSCILLODYNE. No. 106
- HOW TO MAKE THE 2 TO 5 METER TWO-TUBE LOUDSPEAKER SET. No. 107
- HOW TO MAKE THE 3-TUBE BATTERY SHORT-WAVE RECEIVER. No. 108
- THE BRIEF-CASE SHORT-WAVE RECEIVER AND HOW TO BUILD IT. No. 109
- HOW TO BUILD THE POCKET SHORT-WAVE RECEIVER. No. 110
- HOW TO BUILD THE CIGAR-BOX I-TUBE "CATCH ALL" RECEIVER. No. 111
- HOW TO BUILD THE "DUAL-WAVE" SHORT-WAVE BATTERY RECEIVER. No. 112
- HOW TO BUILD THE I-TUBE "53" TWIN-PLEX" RECEIVER. No. 113
- HOW TO BUILD THE PORTABLE MINDYNE SHORT-WAVE BATTERY SET. No. 114
- HOW TO BUILD THE HAM-BAND "PEE-WEE" 2-TUBER. No. 115
- HOW TO BUILD THE DUO-AMPLIDYNE. No. 116
- HOW TO BUILD THE "MONO-COIL 2". No. 117

RADIO BROADCAST RECEIVER AND SPECIAL RADIO PUBLICATIONS

- HOW TO MAKE THE A.C.-D.C. "CASH BOX" RECEIVER. No. 118
- HOW TO MAKE BEGINNER'S 2-TUBE ALL-WAVE SET. No. 119
- HOW TO BUILD THE "RADIO-LAMP" 4-TUBE TABLE RECEIVER. No. 120
- HOW TO BUILD A SUPER-SENSITIVE ALL-WAVE CRYSTAL SET. No. 121
- HOW TO BUILD THE 2-TUBE "PENTODE PORTABLE" BROADCAST SET. No. 122
- HOW TO BUILD THE RADIO "TREASURE" FINDER. No. 123
- HOW TO BUILD THE GERNSBACK ONE-TUBE PENTODE LOUDSPEAKER SET. No. 124
- HOW TO BUILD THE WORLD'S SMALLEST ONE TUBE BATTERY RADIO. No. 125
- HOW TO BUILD A 6-TUBE BATTERY ALL-WAVE "FARM PORTABLE" SET. No. 126
- HOW TO MAKE AN A.C.-D.C. ONE-TUBE "DEAF AID." No. 127
- HOW TO BUILD A PIANOTRON. No. 128
- HOW TO BUILD THE ONE-DOLLAR RADIO. No. 129
- HOW TO MAKE A VARIABLE-TONE CODE PRACTICE SET. No. 130

MECHANICAL PROJECTS PUBLICATIONS

- HOW TO MAKE A SOUTH SEA OUTRIGGER CANOE. No. 131
- HOW TO BUILD A PEE-WEE AUTOMOBILE. No. 132
- HOW TO BUILD A DUAL-CONTROL GLIDER. No. 133
- HOW TO BUILD A HOUSEBOAT ON PONTOONS. No. 134
- HOW TO MAKE A BAND SAW FROM OLD AUTO PARTS. No. 135
- HOW TO BUILD A REAL LATHE FOR \$5.00. No. 136
- HOW TO BUILD A SAIL CAT-BOAT. No. 137
- HOW TO BUILD A SIMPLE PORTABLE REFRIGERATOR. No. 138
- HOW TO BUILD A XYLOPHONE. No. 139
- HOW TO BUILD THE ROWMOBILE. No. 140
- HOW TO BUILD LARGE TESLA AND OUDIN COILS GIVING 18-INCH SPARKS. No. 141
- HOW TO MAKE AN ARC WELDER. No. 142
- HOW TO USE AN A.C. ARC WELDER. No. 143
- HOW TO MAKE YOUR OWN MICROSCOPE. No. 144
- HOW TO MAKE A WIMSHURST ELECTROSTATIC MACHINE. No. 145
- HOW TO MAKE A POWER DRILL PRESS FROM SCRAP PARTS. No. 146
- HOW TO BUILD A GOOD LATHE FOR \$1.00. No. 147
- HOW TO MAKE AND EXPERIMENT WITH AN ELECTROPHOROUS. No. 148
- HOW TO MAKE AN ELECTRIC ARC WELDER FROM AN AUTOMOBILE GENERATOR. No. 149

RADIO PUBLICATIONS, 25 West Broadway, NEW YORK, N. Y. RC 1042

I enclose \$..... for the publications listed by number, at right, at the rate of 50c FOR ANY TEN PUBLICATIONS. NO ORDER FOR LESS THAN 50c ACCEPTED. \$1.00 for 24 publications. These publications are to be sent to me postpaid. I have placed a circle around each number which I want.

Name	Address	101	102	103	104	105	106
City	State	107	108	109	110	111	112
		113	114	115	116	117	118
		119	120	121	122	123	124
		125	126	127	128	129	130
		131	132	133	134	135	136
		137	138	139	140	141	142
		143	144	145	146	147	148
							149

10 BEST RADIO BOOKS 10 CENTS EACH

RADIO FANS EVERYWHERE—these fine ten cent text books give you an excellent foundation for the study of RADIO. They are clearly written, profusely illustrated and contain over 15,000 words in each book. You'll be

- No. 1—HOW TO BUILD FOUR DOERLE SHORT WAVE SETS
- No. 2—HOW TO MAKE THE MOST POPULAR ALL-WAVE I- AND 2-TUBE RECEIVERS
- No. 3—ALTERNATING CURRENT FOR BEGINNERS
- No. 4—ALL ABOUT AERIALS

amazed at the wealth of information contained in these handy books. Excellent for reference—ideal for every technical library. YOUR MONEY BACK if you are not satisfied. PROMPT SHIPMENTS

- No. 5—BEGINNERS' RADIO DICTIONARY
- No. 6—HOW TO HAVE FUN WITH RADIO
- No. 7—HOW TO READ RADIO DIAGRAMS
- No. 8—RADIO FOR BEGINNERS
- No. 9—SIMPLE ELECTRICAL EXPERIMENTS
- No. 10—TELEVISION

BOOKS ARE ALL UNIFORM

Every book in the GERNSBACK EDUCATIONAL LIBRARY has 32 pages—with illustrations varying from 30 to 66 in number. Each title volume contains over 15,000 words. Positively radio's greatest book buy! If you do not think these books worth the price asked, return them in 24 hours and your money will be instantly refunded.

RADIO PUBLICATIONS • 25 WEST BROADWAY • NEW YORK, N. Y.

RADIO PUBLICATIONS, Dept. RC-1042
25 WEST BROADWAY, NEW YORK, N. Y.

Gentlemen: Please send immediately, POSTPAID, the book numbers circled below, I am enclosing cents—each book being 10c.

1	2	3	4	5	6	7	8	9	10
								NEW	NEW

Send FREE listing of 48 new 10c publications.

Name Address

City State

Remit by check or money order—register letter if you send cash or unused U. S. postage stamps.

MAIL COUPON TODAY!

ANALYSIS AND ALTERATION OF AN ANALYZER

(Continued from page 58)

volved to be handled readily by the simple Ohm's law. They state that: (1) The sum of all currents entering any one junction in any network must equal the sum of currents leaving that junction. (Algebraic in the case of D.-C. and unity power factor A.-C. currents and vectorial in the case of reactive A.C. currents.) (2) The sum of potential gradients about any closed loop in any network must total zero. (Algebraic in the case of D.-C. and vectorial in the case of A.-C.).

The unknown currents are set up as algebraic quantities and their direction of flow are assumed in a logical and consistent fashion, of course, and the various algebraic equations are set up to represent the various voltage drop and current conditions according to these laws. These equations are then set up as appropriate simultaneous equations and solved by a series of substitutions and further simultaneous equations, etc., until all the unknowns are solved. The trick to applying these laws lies in the consistency and intelligence with which the choice of equations and substitutions are made.

Suppose we wanted an R-times-100 resistance range. We can set up the R-times-10 range with an assumed full battery voltage of 1.5 volts and with a short circuit across the test leads for a full-scale meter deflection of 50 μ a. We can then solve for the correct setting of the zero-setting potentiometer with a full 1.5-volt battery potential. We can also theoretically insert a test resistor of exactly 1,000 ohms across the test leads and since this 100 mark on the ohms scale corresponds to the 10 marking on the volts-mils scale, we know we must have a meter current of 10 μ a for this test resistor. Thus we have a second method and a check for finding the theoretical setting for the zero-set resistor with a full-voltage battery. Having found this value (using Ohm's law and the parallel-resistance formula), we can then set up a simple chart showing the various ohms ranges and their resistances (see diagram 7). We find that the two sets of resistors that vary with the ranges change roughly in direct proportion to the R multiplier, that is, the resistors increase 11 times to 10 for the R multiplier. Thus, if we assume a value of about 185 ohms for our new series resistor for our new R-times-100 range, we can solve for our new shunt resistor by assuming the same zero-set resistor value as was found for the R-times-10 range and using Kirchoff's law and some elementary algebra. We will finally arrive at a value of about 2,255 ohms for the new shunt resistor. This is close to the approximate value of about 2,300 ohms we would expect from an inspection of the chart of the other ohms ranges.

It must be remembered that we assumed a full battery voltage of 1.5 volts. For accurate calculations we would have to obtain volts-age-load curves for the particular battery being employed in the analyzer.

Obviously, the best and simplest procedure would be to employ a variable resistor of 2,500 ohms for the shunt leg and a variable unit of 200 ohms for the series leg temporarily. Then using a set of one-tenth of one per cent precision wire-wound resistors as test standards across the leads, we can juggle our two variable legs till we obtain the most accurate meter readings.

Obviously, the general circuit as used for

(Continued on page 64)

BOOK REVIEWS

VACUUM TUBE VOLTMETERS by John F. Rider. Published by John F. Rider Publisher, Inc. Stiff cloth covers, size 5¼ x 8 ins., 179 pages. Price \$1.50.

John Rider places the inception of the vacuum-tube voltmeter in 1895. While this date coincides with the invention of the Fleming valve (the diode), the reference is not strictly correct. Nor is a second observation any more accurate than with the invention of the triode in 1907 "engineers were quick to realize the improvement which could be made by using it in v-t voltmeters." The mere use of a meter in combination with a tube does not make a vacuum-tube voltmeter—not any more than a horseshoe magnet and a pivoted coil make a meter.

Vacuum-tube voltmeters as we know them today are of relatively recent development. The few isolated developments prior to 1920 are, of course, not to be belittled, but their use was extremely limited principally because of their erratic behavior. Even the v-t voltmeters of the early "Twenties, beginning with the work of E. B. Moullin, who has probably done more than any other single investigator for such instruments, remained temperamental laboratory tools. It is significant that Mr. Rider's own book, *Practical Testing Systems* (published in 1930), which contained a chapter on v-t voltmeters, said: "To safeguard against errors, the voltmeter should be checked for calibration at two or three points every day that it is used."

Mr. Rider in his current book is more concerned with the practical rather than historical aspects of v-t voltmeters, and he is content with his inclusion of a fairly complete bibliography at the end of the book for historians.

The analysis is practical, there being almost complete absence of formulas. The amount of laboratory work done in the preparation of the book made it unnecessary to include equations, according to the author. The whole field of v-t voltmeters is discussed rather thoroughly and values for component parts are given where they were available to the author.

The reader may find interest in reading about the principles and practices of v-t voltmeters, but by and large, he will get his money's worth from the working diagrams which he can use for constructing such instruments.

ACOUSTICS, by Alexander Wood, M.A., D.Sc. (Glas.). Published by Interscience Publishers, Inc. Stiff cloth covers, size 5¼ x 8½ ins., 588 pages. Price \$7.00.

Dr. Wood is a lecturer in experimental physics at Cambridge University. Perhaps it is characteristic of English lecturers to delve thoroughly—and leisurely—into such a subject as acoustics and to describe in minute detail all the analytical aspects that fit into its pattern. The result, in *Acoustics*, is a comprehensive text suitable for the advanced student possessed of sufficient mathematical background to digest its contents.

Although the author presents practical material, it is outweighed by the amount of theoretical discussion in the beginning of the book. But as the book progresses, the balance shifts the other way. Towards the end the professor, apparently eager to

finish his course, resorts to cramming. The data on electro-acoustics, therefore, is brief and to the point, and is almost non-mathematical.

Because the application of acoustics is so dependent on measurements, emphasis is given to laboratory test methods, and many diagrams and sketches are used to illustrate the text. An enormous amount of information is contained in its pages. Experiments long conducted and long since forgotten will be quizzically examined.

Gauze tones, using a piece of gauze and a flame, or oscillations maintained by electrical heating are to be found. The data once published by an English physicist on production of sound by solidified carbon dioxide (dry ice) didn't show up here (if memory serves us right, the description was written by a woman and appeared in the *Journal of Scientific Instruments*), but it is undoubtedly contained elsewhere in the text.

The classical controversies on combination tones that have been carried on for more than a century (as probably the analogous side-band theories or the existence of ether will be) are described. A drawing, however, shows quite a modern method and apparatus for demonstrating combination tones, using a "piezo-electric" (probably a Rochelle-salt crystal) microphone, an amplifier and several other pieces of equipment.

There is information on supersonics, sound-ranging (for locating enemy guns) and, of course, binaural listening for aircraft detection, and so many other subjects that this book undoubtedly will become—if it has not already become—a reference source for reference sources.

RADIO CODE MANUAL, by Arthur R. Nilson, published by McGraw-Hill Book Company, Inc., Flexible covers, special wire binding, size 5 x 7½ inches, 170 pages. Price \$2.

Anyone who has worked with radio code knows there is more to it than learning the alphabet and numerals in terms of dits and dahs. Hams can tell whether you're a seasoned veteran or a neophyte before you can say Jack Robinson.

It is a pleasure to listen to clear, sharp signals as they cut the air, giving as much significance to spaces as to characters. Jerky, jumbly sending tires the ear to the point of unwillingness to listen. It is, after all, the transmission of intelligence we are after, and the burden falls upon the sender to make himself understood.

Because the process of code learning requires memorizing the sounds of individual letters, which later become a function of the subconscious mind, it is essential that the learning process be correct. The necessity for learning from an able instructor can not, therefore, be too strongly emphasized. Where individual instruction can not be arranged, a book such as *Radio Code Manual* is the next best thing.

The author, Arthur R. Nilson, is an old hand at training radio students. He is chief instructor of the Nilson Radio School and is a retired lieutenant of the U. S. Naval Reserve. He is co-author, with J. L. Horning, of such well known books as "Practical Radio Communications" and "Radio Operating Questions and Answers."

Radio Code Manual contains twenty lessons in learning the code, gives instructions for building code-practice equipment and contains a lot of useful information for the beginner. The author's intention is that the beginner learn not only to send and read code, but also that he be able to handle commercial messages and press matter. Various abbreviations and tricks of the trade that have grown up with the art of radio code are given so that the trainee will be able to understand the use of the advanced methods practiced by operators. Special information required for ship-to-shore communications as well as commercial operating are included.

This book is recommended to radio code instructors of the numerous code classes begun since our entrance into the war, since its use would help to standardize teaching methods.

AMERICAN STANDARD DEFINITIONS OF ELECTRICAL TERMS. Published by the American Institute of Electrical Engineers. Stiff cloth covers, size 7¼ x 11 ins. 311 pages. Price \$1.00.

The American Institute of Electrical Engineers, acting with the approval of the American Standards Association, undertook, in 1928, the project of preparing "definitions of technical terms used in electrical engineering, including correlation of definitions and terms in existing standards."

Forty-three Institute members, representing thirty-three organizations, including national engineering, scientific and professional societies, trade associations, government departments and miscellaneous groups were organized under this plan. Eighteen subcommittees, with personnel of about 120, divided the work, consulting also non-member experts. More than 300 men in all fields helped prepare the definitions.

The reports were widely publicized and circulated for criticism and revision both in and out of the AIEE. This work was carried on until 1941, when final changes were made and the completed report submitted to the members for approval. *American Standard Definitions of Electrical Terms*, now published in a bound volume, received official approval by the AIEE and ASA.

The definitions give the meaning generally associated with each term in electrical engineering work in this country, with the greatest weight given to strictly engineering applications. Since it was planned so that a preferred definition be a simple one, the tendency is toward the simple statement of function rather than to the explicit description of all the properties to which a term refers. Because of similarity of terminology in the many branches of electrical engineering, the index refers to numbers which give the key to the section in which each term is to be found. Cross-indexing is used to avoid unnecessary duplication.

Electrocommunication, including radio and television, takes up 28 pages, and five pages are allotted to electronics, but numerous terms generally believed to belong to radio but which actually have had prior use in other electrical branches are listed in various sections of the book.

Mathematical expressions were used only where they were considered to be essential to the simplest description. Only two illustrations were found in the book.

DE LUXE GENUINE VIBROPLEX

World's Finest Semi-Automatic Key

The smartest looking, smoothest action, easiest to operate "Bug" Vibroplex has ever produced. Has Patented Jewel Movement found only in De Luxe Vibroplex Keys. Precision construction including DIE CUT contact and main spring, colorful red switch knob, finger and thumb pieces and silk cord and wedge. Large contacts. An outstanding key in smartness, signal quality, speed and ease of operation, users say. Vibroplex keys give quality performance—insist on Vibroplex. Three De Luxe Vibroplexes—Lightning Bug, Original and Blue Racer. The finest semi-automatic keys money can buy. Place your order NOW! Money order or registered mail. Write for catalog of Vibroplex keys priced from \$9.95 to \$19.50.

Send for Free Catalog

The Vibroplex Co., Inc.
833 BROADWAY NEW YORK, N. Y.

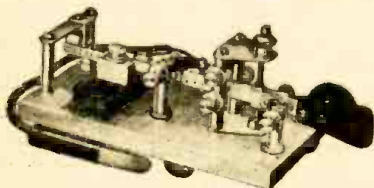

NEW CATALOG

OF SOUND AMPLIFYING SYSTEMS

AUDIOGRAPH Sound Systems represent the latest in Public Address equipment—a complete line plus pre-tested accessories.

NEW LOWER PRICES

Outstanding quality and performance at prices that help you meet any competition.

WRITE FOR YOUR FREE COPY

AUDIOGRAPH

THE FIRST NAME IN SOUND

John Mack Industries—Liberty of Pennsylvania Ave., Plymouth, Ind.

NEW! FREE CATALOG

RADIO SOUND ELECTRONICS PARTS SUPPLIES

FAST EMERGENCY SERVICE

WRITE TODAY

The BIG book of BIG values! Standard Radio and test equipment, thousands of parts for Radio, Electrical and Electronic assemblies. Nation-wide service with Teletype connections for speed and dependability. Engineers, laboratory workers, servicemen and industrial plants look to Lafayette for everything in radio. Write for catalog RC10 today.

Lafayette RADIO CORP.
901 W. JACKSON, CHICAGO
265 PEACHTREE ST. ATLANTA

New Handy

UNIVERSAL REPLACEMENT CAPACITORS

Write for Catalog

SOLAR MFG. CORP., Bayonne, N. J.

USED Correspondence Courses

COMPLETE HOME-STUDY COURSES and educational books, already used. Sold, rented, exchanged. All subjects. Money-back guarantee. Cash paid for used courses. Full details and illustrated 70-page bargain catalog FREE. Write today!

NELSON COMPANY, 500 Sherman, Dept. K-210, Chicago

ANALYSIS AND ALTERATION OF AN ANALYZER

(Continued from page 62)

all the ohms ranges in this analyzer can not be used for an *R* times one tenth or an *R* times one hundredth range since the shunt resistor becomes so small as to draw a ruinous current from the battery. Some sort of shunt type of ohmmeter circuit is advisable for such low-reading ranges as well as heavy low-resistance test leads.

(To be concluded in next issue)

HOME RECORDER ARTICLE

In the article "Construct a Home Recorder" which appeared in the June 1942 issue, page 602 some of the values were not indicated. In response to the numerous queries we obtained the required information from Mr. LeKashman, the author of the article, who adds also the correction for the speaker field D.C. resistance.

- C1—16 mf., 450V
- C2—10 mf., 25V
- C3—.01, 600V
- C4—.006, 600V
- C5—10 mf., 50V
- R1—.25 meg., ½ watt
- R2—.5 meg., potentiometer
- R3—.2 meg., ½ watt

The 100-ohm Speaker Field should be changed to 1000 ohms. In case a magnetic cutter is used the grid resistor of all the tubes should be reduced to give less bass and more intelligible speech.

11-TUBE FREQUENCY MODULATION RECEIVER

(Continued from page 43)

AMPHENOL SOCKETS

- Nine Octal sockets
- One Amphenol above chassis octal socket
- One tuning eye indicator for eight prong socket octal

TUBES; RCA OR SIMILAR

- Three 6AC7 or 1852 tubes
- One 6SA7
- One 6SJ7
- One 6H6
- One 80
- One 6SC7
- One 6SF5
- One 6F6G
- One 6AD6 dual tuning indicator tube

MISCELLANEOUS PARTS

- One CRL single pole double throw switch, for tone control
- Soldering terminals
- No. 16 copper wire, covered for wiring
- One tuning unit three gang. See text, or use Browning unit rewound or one wholesale radio condenser part, No. K10332, three gang F/M
- One K10327 antenna coil
- One K10328 RF mixer coil
- One K10329 oscillator coil
- Solder, nuts, bolts, etc., and tuning indication holder and socket, Amphenol

SYLVANIA TUBES

- Three type 6AC7/1852
- One type 6H6
- One type 6SJ7
- One type 80
- One type 6SA7
- One type 6SF5
- One type 6SC7
- One type 6F6G
- One type 6AD6 tuning indicator, dual type 12 inches 6 wire cable for tuning eye indicator

TRIMMERS—CONDENSERS

- Three 3-25 or 30 mmf. trimmers

MANUAL ON G.E. RECEIVING TUBES

A 24-page technical manual on G.E. radio receiving tubes, prepared to assist those who work or experiment with radio tubes and circuits, has been released by the Renewal Tube Sales Section of the General Electric Radio Television and Electronics Dept., Bridgeport, Conn. The manual can be obtained by radio Servicemen, radio technicians, experimenters, radio amateurs, and others technically interested in radio tubes by writing to the G.E. department.



HIGH EFFICIENCY results in Sound National Defense that is why NATIONAL DEFENSE SOUND SYSTEMS are equipped with University Reflex HIGH POWER LOUDSPEAKERS UNIVERSITY LABS. 195 CHRYSLER ST. N. Y. C.

RADIO KITS—Ready To Wire

Tremendous quantity of standard parts, suitable for kits. Complete in every detail. All hardware, tubes, parts. Diagrams furnished. Latest parts catalog—FREE. McGEE RADIO, R-2055, Kansas City, Mo.

Index to advertisers

Amperite Corp.	58
Audel & Co., Theo.	Back Cover
Audiograph	64
Burstein-App'ebec Co.	52
Candler System Co.	47
Cannon Co., C. H.	52
Capitol Radio Engineering, Inc.	49
Chartered Institute of America	54
Commercial Radio Institute	47
Delson Radio Co.	54
General Cement Mfg. Co.	57
Gold Shield Products	54, 57
Hallcrafters, Inc.	Inside Back Cover
Harrison Radio	52
Henry Radio	53
Hudson Specialties Company	55
Hygrade Sylvania Corp.	4
Korrol Mfg. Co.	52
Lafayette Radio Co.	64
Lancaster, Allwine & Rommel	54
Lincoln Engineering School	47
Mass. Radio School	49
McGee Radio	64
McGraw-Hill Book Co.	61
Meissner Manufacturing Co.	31
Melville Aeronautical School of Radio	58
Murdock Mfg. Co.	3
National Radio Institute	1
National Union Corp.	38
Nelson Co.	64
N. Y.-YMCA Schools	49
Ohmite Manufacturing Co.	5
Opportunity Adlets	53
Peerless Sound & Radio Co.	50
Premax Products	53
Prentice-Hall	6
Radcraft Publications, Inc.	51, 54, 59
RCA Institutes	49
Radio Publications	62
Radio-Television Institute	33
Radio & Television	57
Radolek Co.	35
Readrite Meter Works	41
Schott Co., Walter L.	54
Solar Manufacturing Co.	64
Sprague Products Co.	33
Sprayberry Academy of Radio	41
Supreme Instruments Corp.	49
Technifax	53, 56
Telex Company	47
Treasury Department	44
Triplet Electric Instruments Co.	Inside Front Cover
U.S. Army Recruiting Induction Service	45
University Laboratories	64
Vibroplex Co.	64
X. L. Laboratories	47

(While every precaution is taken to insure accuracy, we cannot guarantee against the possibility of an occasional change or omission in the preparation of this index.)



Now! FOR THE *First Time*
YOU CAN ENLIST IN THE
U. S. ARMY SIGNAL CORPS!

... restrictions have been cut to a minimum. If you are eighteen to nineteen and physically fit, you can enlist directly into the U. S. Army Signal Corps ... if you are nineteen to forty-five and can pass the physical examinations, you can enlist providing you have some experience in the Communications Industry and have not received your notice for induction.

the hallicrafters co.
CHICAGO, U. S. A.
Keep Communications Open

PRACTICAL RADIO INFORMATION

Including Frequency Modulation—Television, etc.

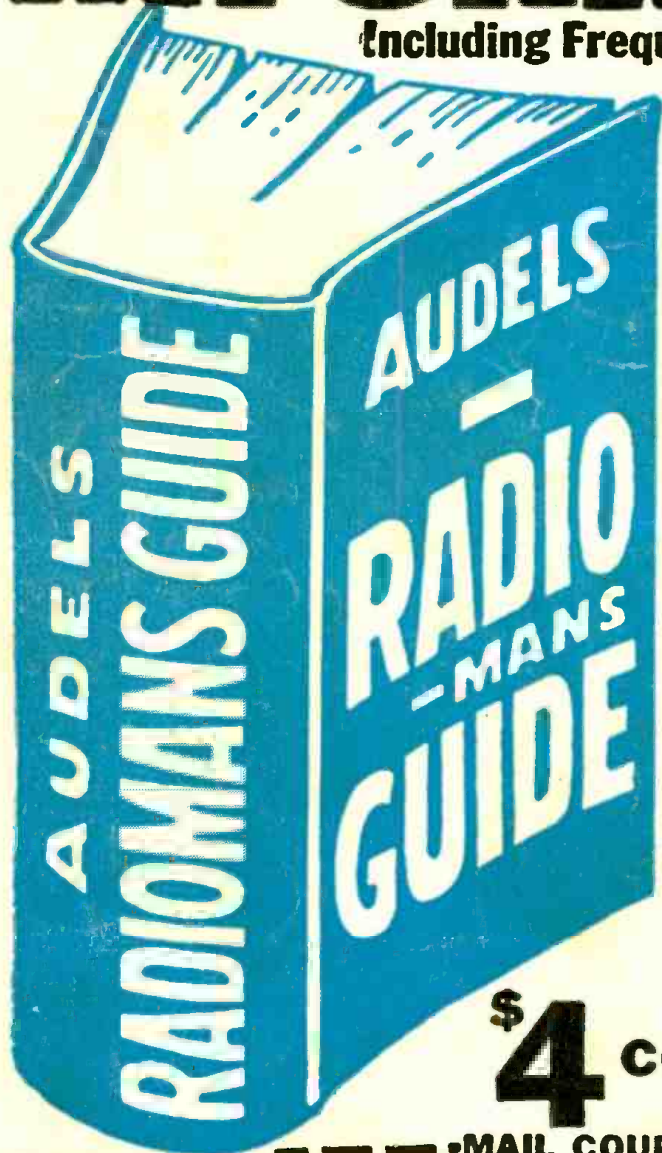

Inside Information for all Servicemen—Aircraft Pilots, Students.

772 PAGES, 400 DIAGRAMS

is complete—gives Authentic Principles & Practices in Construction, Operation, Service & Repairs. Covers clearly and concisely Radio fundamentals—Ohm's Law—Physics of sound as related to radio science—Measuring instruments—Power supply—Resistors—Inductors—Condensers—Transformers and examples—Broadcasting stations—Radio Telephony—Receivers—Diagrams—Construction—Control systems—Loud speakers—Antennas—Auto Radio—Phonograph pickups—Public Address Systems—Aircraft & Marine Radio—Radio Compass—Beacons—Automatic Radio Alarms—Short Wave—Coil Calculations—Testing—Cathode ray oscillographs—Static Elimination—Trouble Pointers—Underwriter's standards—Units & tables. REVIEW QUESTIONS—Ready Reference Index.

\$4

COMPLETE • PAY \$1 A MO.

To get this practical information in handy form—Fill in and

—MAIL COUPON TODAY.—

AUDEL, Publishers; 49 West 23rd St., New York
Mail AUDELS NEW RADIOMAN'S GUIDE for free examination. If O. K. I will send you \$1 in 7 days; then remit \$1 monthly until \$4 is paid. Otherwise I will return it.

Name _____ R.C.F.

Address _____

Occupation _____

Reference _____

Please Note:
If you do not wish to mar this page by clipping coupon—send letter or penny postcard instead.